



LEICA C-LUX







INSTRUCTIONS

All new
Leica Fotos
functions

OK

Finding the information you need

In these instructions, you can find the information you need from the following pages.

Search from “Table of Contents”	 4 -
Search from the list of function names “Contents by Function”	 10 -
Search from “Names and Functions of the Main Parts”	 15 -
Search from “List of monitor/viewfinder displays”	 269 -
Search from the list of on-screen messages “Message displays”	 275 -
Search from the menu list	 164 -
Search from “Q&A Troubleshooting”	 277 -

For details on how to use these instructions, see the next page.

How to use these instructions

Recording mode icons

Recording modes: 

In recording modes that show icons in black, you can select and execute the indicated menus and functions.

 (Custom Mode) has different functions depending on the recording mode that is registered.

■ About the symbols in the text

MENU Indicates that a menu item can be set after pressing the [MENU/SET] button.



Wi-Fi Indicates that a Wi-Fi setting can be made after pressing the [Wi-Fi] button.





[AE|AF LOCK], [DISP], , etc. indicate the respectively labeled buttons.

 Tips for skillful use and points for recording.

(→00) Indicates the reference page.

In these instructions, steps for setting a menu item are described as follows:

MENU →  [Rec] → [Quality] → 

- These instructions indicate the up, down, left, and right cursor buttons as    .
- Ring, dial and lever operations are illustrated as below.

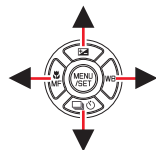



Turn the control ring	
Rotate the thumb dial	
Rotate the zoom lever	

Table of Contents

- Finding the information you need 2
- How to use these instructions 3
- Contents by Function 10

Before Use

- Before use 12
- Scope of Delivery 14
- Accessories 14
- Names and Functions of the Main Parts 15

Preparations

- Attaching the Wrist Strap 17
- Charging the Battery 18
 - Inserting the battery 19
 - Charging the battery 20
- Inserting and Removing the Card ... 24
- About the Card 25
 - Formatting the card (initialization) 26
 - Estimated recording capacity (number of pictures/recording time) 26
- Setting Language, Time, and Date 28

Basics

- Holding the Camera 30
- Buttons/Ring/Dials/Levers Used for Recording 31
 - Switching between viewfinder and monitor displays 31
 - How to use the lens' zoom function 32
 - Taking pictures 33
 - Recording videos 33
 - How to use the mode dial 34
 - Control ring / Thumb dial 35
 - Cursor buttons / [MENU/SET] button (Selecting/setting items) 36
 - [DISP] button (Switching the display information) 36
- Touch screen operations 39
 - Focusing on the subject at the touched position (Touch AF, Touch Shutter) 40
 - Adjusting the exposure based on the touched subject detail ([Touch AE]) 41
- Menu Control 42
- Quick Menu 44
 - Customizing the Quick Menu 45
- Assigning Frequently used Functions to the Buttons (Function buttons) 46
 - Using the function buttons during recording 47
 - Using the function buttons during playback 48
- Changing the Settings Assigned to the Control Ring/Thumb Dial 49
- Entering Text 50

Recording Modes

■ Snapshot Modes	51	■ Scene Modes	67
[Snapshot Mode] menu.....	53	Types of Scene Modes	68
Setting coloring.....	54	■ Taking Pictures	
Setting brightness (exposure)/		with Different Effects	
blurriness of the background		(Creative Control Mode)	71
(Defocus control function).....	55	Types of picture effects.....	72
■ Taking Pictures Using the		■ Creative Video Mode	77
Exposure Control Modes		Recording Slow Motion Videos	
(P, A, S, and M)	56	([High Speed Video])	78
Program exposure mode	56	Panning or zooming while recording	
Aperture Priority Exposure Mode.....	57	with the camera in a fixed position	
Shutter-Priority Exposure Mode.....	58	([4K Live Cropping]).....	79
Manual Exposure Mode.....	59	■ Registering your own	
Checking the effects of the aperture		settings and recording	
value and shutter speed settings		(Custom Mode)	81
(Preview Mode).....	62	Registering your own settings	
Easily set aperture value / shutter speed		([Cust.Set Mem.].....)	81
for suitable exposure (One Push AE)	63	Recording using a registered	
■ Recording panorama pictures	64	custom set	82

Focus, Brightness (Exposure) and Color tone Settings

■ Using Autofocus	83	■ Taking close-up pictures	96
Set the focusing operation to be performed when the shutter button is pressed halfway (AFS, AFF, AFC)	84	■ Taking pictures with Manual Focusing	97
Switching [AF Mode]	85	■ Taking pictures by locking the focus and/or exposure settings	99
Changing the position and size of the AF area	91	■ Taking pictures with Exposure Compensation	100
Setting the AF area position by touch	94	■ Setting the ISO Sensitivity	101
Optimizing the focus and exposure settings for a touched position	95	■ Setting the White Balance	103

4K Photo and Drive Settings

■ Recording with the 4K Photo function and selecting pictures to save	108	■ Selecting a Drive Mode	124
Recording with the 4K Photo function	108	Continuous exposure function	125
Selecting pictures from 4K photo series files and saving	111	Taking pictures with the self-timer	127
Notes on the 4K Photo function	116	■ Taking Picture Series with Automatically Changing Settings (Bracket Recording)	128
■ Selecting the focusing plane after recording ([Post Focus]/[Focus Stacking])	119	Exposure Bracket	129
Recording using [Post Focus]	119	Aperture Bracket	130
Selecting a focus point and saving the picture ([Post Focus])	121	Focus Bracket	130
Determining subject parts to be in focus by combining several shots and creating a single picture ([Focus Stacking])	122	■ Taking Pictures Automatically at Set Intervals [Time Lapse Shot]	131
Notes on the [Post Focus]/[Focus Stacking]	123	■ Creating stop motion animation [Stop Motion Animation]	134

Stabilizer, Zoom and Flash

- **Compensating Camera Shake** 137
- **Using the Lens' Zoom Function** 139
 - Zoom types and use 139
 - Using Touch zoom 142
- **Taking Pictures with the Built-In Flash** 143
 - Changing the Flash Control Mode 144
 - 2nd curtain sync..... 147
 - Flash exposure compensation..... 147

Recording Videos

- **Recording Videos/4K Videos** 148
 - Setting the resolution and the frame rate 150
 - Focusing while recording videos ((Continuous AF))..... 151
- **Taking Pictures While a Video is Being Recorded** 152
- **Recording Snap Videos**..... 153

Playing Back and Editing Pictures

- **Viewing your pictures**..... 156
- **Viewing Videos**..... 157
 - Extracting single frames from videos..... 158
- **Switching the Playback Method** 159
 - Zooming in and viewing "Playback Zoom"..... 159
 - Viewing a list of pictures "Multi Playback" 159
 - Viewing pictures by their recording date "Calendar Playback" 160
- **Viewing group pictures** 161
- **Deleting pictures**..... 163

Using Menu Functions

■ Menu list	164	[Setup]	196
[Rec]	165	[My Menu]	206
[Motion Picture]	180	[Playback]	207
[Custom]	182		

Wi-Fi/Bluetooth

■ What you can do with the Wi-Fi®/Bluetooth® function	223	■ Sending pictures to a smartphone	245
■ Wi-Fi/Bluetooth Function	224	■ About Wi-Fi connections	249
■ Connecting the camera to a smartphone	227	Connecting via a wireless access point ([Via Network])	249
Installing the smartphone/tablet app "Leica C-Lux"	227	Connecting directly ([Direct])	252
Connecting the camera to a smartphone compatible with Bluetooth Low Energy	228	Connecting quickly with the same settings as used previously ([Select a destination from History] / [Select a destination from Favorite])	253
Connecting the camera to a smartphone that does not support Bluetooth Low Energy	230	■ [Wi-Fi Setup]	255
■ Controlling the Camera with a Smartphone	235		
Turning on/off the camera using a smartphone	235		
Tripping the camera's shutter using a smartphone (remote recording)	236		
Playing back or saving images stored in the camera, or uploading them on social media sites	240		
Transferring recorded images to a smartphone automatically	241		
Writing location information of a smartphone on a recorded image	243		
Synchronizing the camera's clock with a smartphone	244		

Connecting with Other Devices

- **Viewing 4K videos** 256
 - Saving 4K videos 257
- **Viewing on a TV** 258
 - Recording while monitoring camera images 260
 - HDTV Link (HDMI) (HDAVI Control™) 261
- **Copying the Recorded Image Data to a Computer** 262
 - Copying pictures and videos 263
- **Storing recorded pictures and videos in a recorder** 265
- **Printing** 266
 - Printing with date and text 268

Others

- **List of monitor/viewfinder displays** 269
- **Message displays** 275
- **Q&A**
 - Troubleshooting 277
- **Usage cautions and notes** 285
- **Leica Service Addresses** 293



Recording

Recording

Recording mode	34
[Preview]	62
Panorama Shot Mode	64
Macro recording	96
Bracket recording	128
[Time Lapse Shot]	131
[Stop Motion Animation]	134
[Silent Mode]	176
[Multi Exp.]	179

4K Photo

[4K PHOTO]	108
[Post Focus] recording	119

Focus (AF/MF)

Autofocus	83
AF Mode	85
Adjusting the AF area position	91
Manual Focus	97
AF/AE Lock	99

Drive

Drive Mode	124
Serial exposures	125
[Self Timer]	127

Exposure

[Touch AE]	41
[One Push AE]	63
AF/AE Lock	99
Exposure Compensation	100
ISO sensitivity	101
Exposure Bracketing	129
[Metering Mode]	172



Video recording

Video recording

Creative Video Mode	77
[High Speed Video]	78
[4K Live Cropping]	79
[Rec Quality]	150
Taking pictures while a video is being recorded	152
[Snap Movie]	153

Picture Quality and Color Tone

White Balance	103
[Picture Size]	166
[Quality]	167
[Photo Style]	168
[Filter Settings]	170
[Color Space]	171
[Highlight Shadow]	173
[i.Dynamic]	174
[i.Resolution]	174
[Long Shtr NR]	175
[Diffraction Compensation]	176
[HDR]	178

Flash

[Flash Mode]	144
2nd curtain synchro	147
[Flash Adjust.]	147

Monitoring

Recording while monitoring camera images	260
--	-----



Setup/Custom

Basic settings

[Format]	26
[Clock Set]	28
Diopter adjustment	31
Quick Menu	44
[Beep]	198
[Economy]	199
[Reset] (initialization)	205

Customization

Function buttons	46
Custom Mode	81
[Custom] menu	182



Playback

Playback

Picture playback	156
Video playback	157
Playback Zoom	159
Multi Playback	159
Delete	163
[Auto Review]	187
[Slide Show]	208
[Rotate]/[Rotate Disp.]	220, 222

Edit

[Post Focus]	121
[Focus Stacking]	122
[Title Edit]	211
[RAW Processing]	212
[4K PHOTO Bulk Saving]	214
[Light Composition]	215
[Sequence Composition]	216
[Clear Retouch]	217
[Text Stamp]	218
[Resize]	219
[Cropping]	220

Image settings

[Protect]	210
[Rating]	210



Wi-Fi/Bluetooth

Smartphone/tablet app "Leica C-Lux"

Leica C-Lux app	227
Remote start-up	235
Remote recording	236
Auto transfer	241



Connecting with other devices

PC

Copying the Recorded Image Data to a Computer	262
---	-----

TV

Playing back pictures on a TV screen	258
[HDTV Link]	261

Recorder

Dubbing	265
---------------	-----

Printer

PictBridge	266
------------------	-----

Before use

■ Camera handling

Keep the camera away from excessive vibration, force, or pressure.

- Avoid using the camera under the following conditions, which may damage the lens, monitor, viewfinder, or camera body.

This may also cause the camera to malfunction or prevent recording.

- Dropping or hitting the camera against a hard surface
- Sitting down with the camera in your pants pocket or forcing it into a full bag
- Adding accessories to the camera strap
- Exerting excessive force on the lens or monitor

The camera is not dust resistant, splash resistant, or waterproof.

Avoid using the camera in places with excessive dust or sand, or where water can come into contact with the camera.

- Avoid using the camera under the following conditions, which present a risk that sand, water, or foreign material may enter the camera through the lens or openings around buttons. Be especially careful because these conditions may damage the camera, and such damage may not be repairable.

- In extremely dusty or sandy places
- In the rain or by the shore, where the camera may be exposed to water

■ Condensation (When the lens, the monitor, or viewfinder, is fogged up)

- Condensation may occur when the camera is exposed to sudden changes of temperature or humidity. Avoid these conditions, which may make the lens, monitor, or viewfinder dirty, cause mold, or damage the camera.
- If condensation does occur, turn off the camera and wait about two hours before using it. Once the camera adjusts to the surrounding temperature, the fogging will clear naturally.

■ Always take a test shot first

Before important events when you will use the camera (at weddings, for example), always take a test shot to make sure that pictures and sound record correctly.

■ No compensation for missed shots

Leica Camera AG cannot compensate for missed shots if technical problems with the camera or card prevent recording.

■ Carefully observe copyright laws

Unauthorized use of recordings that contain works with copyright for purposes other than personal use is prohibited under copyright law. Recording of certain material may be restricted even for the purpose of personal use.

■ Also refer to “Usage cautions and notes” (→285)

Scope of Delivery

	Order No.
Rechargeable battery pack	
BP-DC15-E	18 544
BP-DC15-U	18 545
BP-DC15-TK	18 546
Battery charger/AC adapter	
ACA-DC16-E	423-118.001-005
ACA-DC16-C	423-118.001-006
ACA-DC16-K	423-118.001-007
ACA-DC16-B	423-118.001-008
ACA-DC16-N	423-118.001-009
ACA-DC16-A	423-118.001-010
ACA-DC16-U	423-106.001-012
USB Cable Micro-B	423-118.001-014
Wrist strap	423-109.001-020
Short instructions	93 856 - 860 (delivery differs depending on markets)
Guarantee Card	439-399.100-026

Accessories

Please visit the Leica Camera AG website for information on the extensive range of Leica C-LUX accessories:

www.leica-camera.com

Notes:

- Memory cards are optional.
- The battery pack is indicated as battery pack or battery in the text.
- SD, SDHC, and SDXC memory cards are referred to as card in the text.
- Check that all items belonging to the scope of delivery are included before using the camera.
- Depending on the country or area where the camera was purchased, the items and their shape may differ from the descriptions and illustrations in these instructions.
- Always keep small parts in a safe place out of the reach of children.
- Please dispose of all packaging appropriately.

Names and Functions of the Main Parts

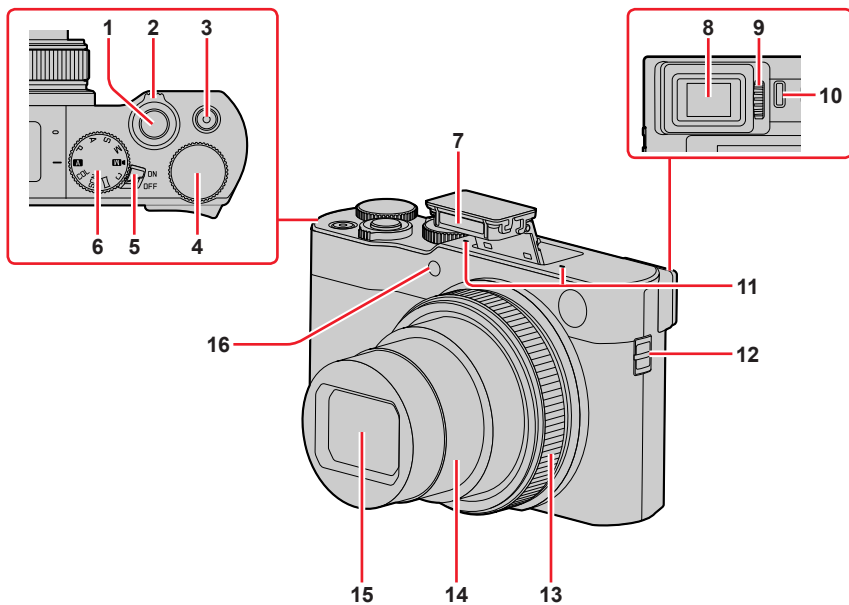

- | | | | |
|-----------|--------------------------------------|-----------|--|
| 1 | Shutter button (→33) | 11 | Stereo microphones (→30, 181)
Be careful not to cover the microphones with your finger. Doing so may impair sound recording. |
| 2 | Zoom lever (→32, 139, 187) | 12 | Strap eyelet (→17) |
| 3 | Video button (→33, 148) | 13 | Control ring (→35, 49) |
| 4 | Thumb dial (→35, 49) | 14 | Lens barrel |
| 5 | Main [ON/OFF] switch (→28) | 15 | Front lens element |
| 6 | Mode dial (→34) | 16 | Self-timer indicator (→127) /
AF Assist Lamp (→30, 184) |
| 7 | Flash (→30, 143) | | |
| 8 | Viewfinder (→31, 269) | | |
| 9 | Diopter adjustment dial (→31) | | |
| 10 | Eye sensor (→31) | | |

Names and Functions of the Main Parts

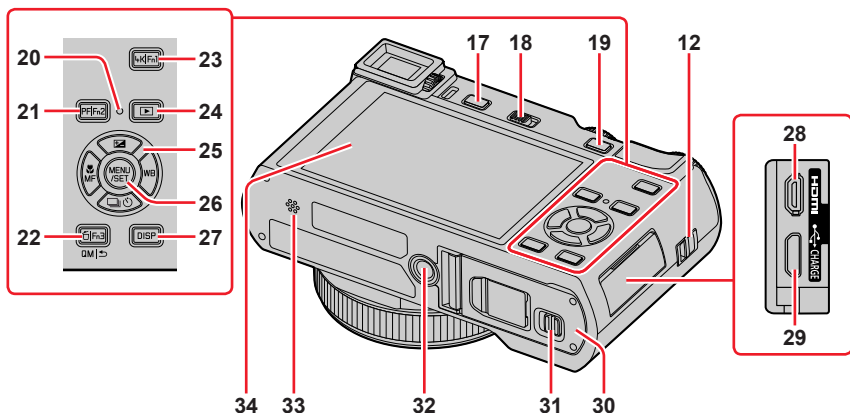

- 12** Strap eyelet (→17)
- 17** [EVF] button (→31) / [Fn4] button (→46)
- 18** Flash release lever (→143)
- 19** [AE|AF LOCK] button (→99)
- 20** Charging lamp (→21) / WIRELESS connection lamp (→224)
- 21** [PF] ([Post Focus]) button (→119) / [Fn2] button (→46)
- 22** [⏎] (Delete) button (→163) / [Q.M.] (Cancel) button (→44) / [Fn3] button (→46)
- 23** [4K] (4K photo mode) button (→108) / [Fn1] button (→46)
- 24** [▶] (Playback) button (→156)
- 25** Cursor buttons (→36)
[⏏] (Exposure compensation) (▲) (→100)
[WB] (White balance) (▶) (→103)
[☺] (Drive Mode) (▼) (→124)
[MF] (Focus Mode) (◀) (→83, 96, 97)
- 26** [MENU/SET] button (→36, 42)
- 27** [DISP] button (→36)

- 28** [HDMI] socket (→258)
- 29** [USB/CHARGE] socket (→20, 263, 266)
- 30** Card/Battery door (→19, 24)
- 31** Release slider (→19, 24)
- 32** Tripod thread (→288)
Using tripod screws with lengths of 5.5mm ($7/32$ ") or more may damage the camera if attached.
- 33** Speaker (→30, 198)
- 34** Monitor (→269) with touch control options (→39)

Function buttons [Fn5] to [Fn9] are touch icons.

They can be called up by touching the [Fn] tab on the monitor screen.

Attaching the Wrist Strap

We recommend attaching the wrist strap when using the camera to prevent it from dropping.

Ⓐ Strap eyelet

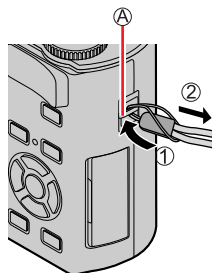

Charging the Battery

Always use the dedicated AC adapter, USB cable, and battery for this camera.

- **Always charge before first use! (battery is shipped uncharged)**
- **Charge the battery while it is in the camera.**

Camera status	Charge
Turned off	Yes
Turned on	No

About batteries that you can use with this camera

It has been found that counterfeit batteries which look very similar to the genuine product are available in some markets. Some of these batteries are not adequately equipped with internal protection to meet the requirements of appropriate safety standards. Using such batteries may lead to fire or explosion. Please be advised that Leica Camera AG is not liable for any accident or failure occurring as a result of use of a counterfeit battery. To ensure that safe products are used we urgently recommend to use only the Leica battery BP-DC15 (→14).

Inserting the battery

To charge the battery, insert it into the camera.

1 Push the release slider to the [OPEN] position and open the card/battery door

(A) Release slider

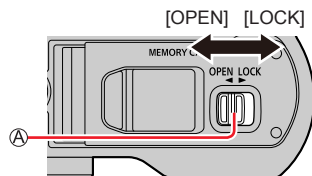

2 Insert the battery all the way

- Insert the battery all the way and check that it is locked by latch.

3 Close the card/battery door and then push the release slider to the [LOCK] position

- (B) Make sure to insert the battery in the correct orientation.
(C) Lever

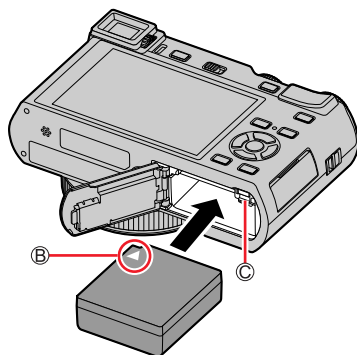

■ To remove the battery

Move the latch in the card/battery compartment in the direction of the arrow.

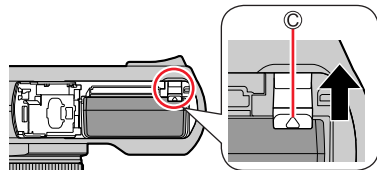

- Use only the Leica battery BP-DC15 (→14).
- Leica Camera AG cannot guarantee the quality of any other type of battery.
- To remove the battery, turn the camera off and wait until the Leica logo on the monitor screen goes off. (Failure to wait may cause the camera to malfunction and may damage the card or recorded data.)
- Remove the battery from the camera if you will not use it for a long period of time.

Charging the battery

We recommend charging in a location where the ambient temperature is between 10°C and 30°C (50°F to 86°F) (same for the battery temperature).

**Insert the battery into the camera.
Make sure the camera is turned off.**

The battery can be charged from an outlet or through a PC.

Ⓐ USB cable

Ⓑ AC adapter

Ⓒ To the electrical outlet

Ⓓ Computer

Getting ready: Turn on the computer.

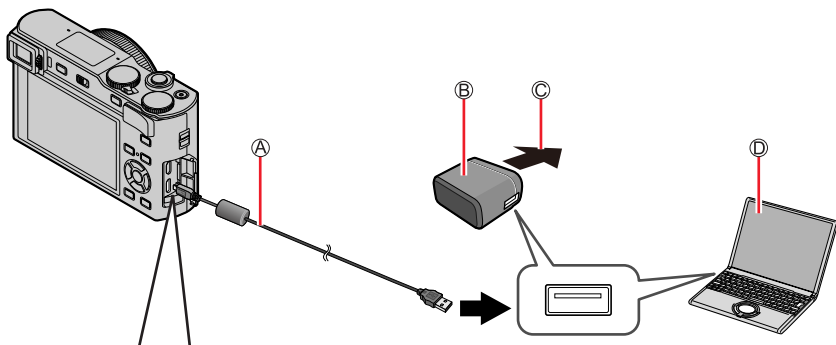

When charging the camera, connect the USB cable to the [USB/CHARGE] socket.

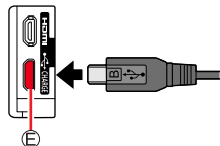

Ⓔ [USB/CHARGE] socket

- This socket is located at the bottom when the camera is in an upright position.
- Always check the orientation of the plug, and hold it straight to insert or remove it. (If it is inserted in the wrong direction, the socket could be deformed and cause faulty operation.) Also, do not insert into the wrong socket. Doing so may damage the camera.

Charging the Battery

- If the computer enters sleep mode during charging, charging may be stopped.
- If a notebook computer that is not connected to an electrical outlet is connected to the camera, the battery of the notebook computer will be depleted. Do not leave the camera and notebook connected for a long period of time.
- Always connect the USB cable to the USB socket on your computer. Do not connect it to the USB socket of the monitor, keyboard, printer, or USB hub.

Charging lamp indications

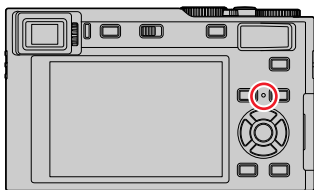
**Charging lamp (Red)**

On: Charging in progress

Off: Charging complete

(After charging stops, disconnect the camera from the electrical outlet or your computer.)

Flashing: Charging error

(For instructions on correcting the problem, refer to (→277).)

Charging the Battery

Notes on charging time

When using the AC adapter

Charging time	Approx. 190 min.
---------------	------------------

- The charging time indicated above is the time required for charging in case the battery is completely depleted. The time required for charging differs depending on conditions of battery usage. Charging takes longer in cases when temperatures are either high or low and when the battery has not been used for a long period of time.
- The time required for charging through the computer varies depending on the power supply capacity of the computer.

- Do not use any other USB cables except the supplied one. Doing so may cause malfunction of the camera.
- Do not use any other AC adapters except the supplied one.
- Do not use a USB extension cable.
- The AC adapter and the USB cable are dedicated accessories of this camera. Do not use them for other devices.
- Remove the battery if the camera will not be used for a long period of time. (The battery may become completely depleted in such a case even after being charged initially.)
- If there is any trouble related to the electrical outlet (i.e. power failure), charging may not complete properly. Disconnect the USB cable and reconnect it to the camera.

Remaining battery**Remaining battery capacity**

If the battery mark flashes red, recharge or replace with a fully charged battery.

Charging the Battery

Estimated number of recordable pictures and operating time

The number of recordable pictures are based on CIPA (Camera & Imaging Products Association) standards.

When a SDHC memory card and the supplied battery are used.

■ Recording pictures (When using the monitor)

Number of recordable pictures	Approx. 370
Recording time	Approx. 185 min.

■ Recording pictures (When using the viewfinder (EVF))

The values in parentheses apply when [EVF Display Speed] is set to [ECO 30fps].

Number of recordable pictures	Approx. 250 (Approx. 350)
Recording time	Approx. 125 min.

■ Recording videos (When using the monitor)

[Rec Quality]	[FHD/28M/60p]	[4K/100M/30p]
Available recording time	Approx. 100 min.	Approx. 90 min.
Actual available recording time*	Approx. 50 min.	Approx. 45 min.

* The time you can actually record when repeating actions such as turning the camera on/off and starting/stopping recording.

■ Viewing pictures (When using the monitor)

Playback time	Approx. 260 min.
---------------	------------------

● The operating times and number of recordable pictures will differ according to the environment and the operating conditions.

For example, in the following cases, the operating times shorten and the number of recordable pictures is reduced.

- In low-temperature environments, such as on ski slopes.
- When functions such as flash and zoom are used repeatedly.
- If the available battery power is significantly reduced, the battery is reaching the end of its lifespan. Please purchase a new battery.

Inserting and Removing the Card

- Make sure the camera is turned off.

1 Push the release slider to the [OPEN] position and open the card/battery door

Ⓐ Release slider

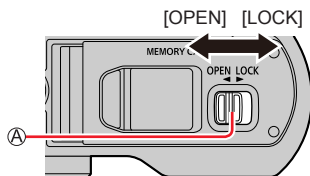

2 Insert the card all the way

Ⓑ Do not touch the terminals

- Check the orientation of a card.
- Insert the card all the way down until it clicks.

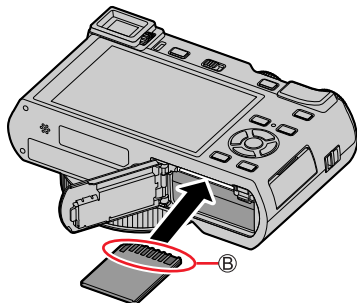

3 Close the card/battery door and push the release slider to the [LOCK] position

■ To remove the card

First, press the card down slightly.

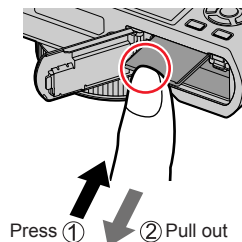

- Keep memory cards out of reach of children to prevent swallowing.
- To remove the card, turn the camera off and wait until the Leica logo on the monitor screen goes off. (Failure to wait may cause the camera to malfunction and may damage the card or recorded data.)

About the Card

The following SD standard-based cards can be used.

Type of Card	Capacity	Notes
SD memory cards	512 MB – 2 GB	• This camera is compatible with UHS-I UHS Speed Class 3 standard SDHC/SDXC memory cards.
SDHC memory cards	4 GB – 32 GB	
SDXC memory cards	48 GB – 128 GB	

■ About video/4K photo recording and speed class ratings

Use a card that meets the following ratings of the SD Speed Class or UHS Speed Class.

- SD Speed Class and UHS Speed Class are the speed standards regarding continuous writing. Confirm the SD speed by checking the card label or other card related materials.

[Rec Quality]	Speed class	Label example
[FHD]/[HD]	Class 4 or higher	CLASS 4 4
[4K]/[High Speed Video]	UHS Speed Class 3	U3
When recording in 4K Photo / [Post Focus]	UHS Speed Class 3	U3

Access to the card

The access indication displays red when pictures are being recorded on the card.



- While the camera is accessing the card (for an operation such as picture data writing, reading, deletion, or formatting), do not turn it off or remove the battery or the card. Do not subject the camera to vibrations, impact, or static electricity. The card or the data on the card may be damaged, and this camera may no longer operate normally. If operation fails due to vibration, impact or static electricity, perform the operation again.
- If you set the write-protect switch to "LOCK", you may not be able to write, delete or format the data or display it by recording date.
- It is recommended that you copy important pictures to your computer (as electromagnetic radiation, static electricity, or faults may cause data to be damaged).



Formatting the card (initialization)

Format the card before recording a picture with this camera.

Since data cannot be recovered after formatting, make sure to back up necessary data in advance.

MENU →  **[Setup]** → **[Format]**

- This requires a sufficiently charged battery.
- Do not turn off the camera or perform other operations during formatting.
- Always format cards with this camera. Please reformat the card with this camera if it has already been formatted with a computer or another device.

Estimated recording capacity (number of pictures/recording time)

The number of photos you can take and the recording time vary in proportion to the card capacity (and depending on recording conditions and type of card).

Recording picture capacity

When **[Aspect Ratio]** is set to **[3:2]** and **[Quality]** is set to **[**

[Picture Size]	16 GB	32 GB	64 GB	128 GB
L (20M)	1450	2910	5810	11510
EX M (10M)	2650	5310	10510	20810
EX S (5M)	4600	9220	17640	34940

When **[Aspect Ratio]** is set to **[3:2]** and **[Quality]** is set to **[**

[Picture Size]	16 GB	32 GB	64 GB	128 GB
L (20M)	450	920	1840	3650
EX M (10M)	530	1070	2140	4250
EX S (5M)	580	1170	2340	4630

- When the number of recordable pictures exceeds 9,999, "9999+" is displayed.

Recording time capacity (videos)

- The recordable time is the total time of all the videos which have been recorded. ([h], [m] and [s] indicate "hour", "minute" and "second".)

[Rec Quality]	16 GB	32 GB	64 GB	128 GB
[4K/100M/30p] [4K/100M/24p]	20m00s	41m00s	1h25m	2h45m
[FHD/28M/60p]	1h10m	2h25m	5h00m	9h55m
[FHD/20M/30p]	1h35m	3h15m	6h40m	13h15m
[HD/10M/30p]	3h05m	6h20m	12h45m	25h20m

- MP4 videos with a [Rec Quality] size of [FHD] or [HD]:
Recording stops when the continuous recording time exceeds 29 minutes.
The video files are split into smaller ones for recording and playback if the file size would otherwise exceed 4 GB. (You can continue to record such a video without interruption.)
- MP4 videos with a [Rec Quality] size of [4K]:
Recording stops when the continuous recording time exceeds 15 minutes.
When using an SDHC memory card, files are split into separate ones for recording and playback if the file size would otherwise exceed 4 GB. (You can continue to record such a video without interruption.)
If using an SDXC memory card, you can record a video in a single file even if the size is greater than 4 GB.
- The maximum available continuous recording time is displayed on the monitor screen.**

Setting Language, Time, and Date

The clock is not set when the camera is shipped.

1 Set the main [ON/OFF] switch to [ON]

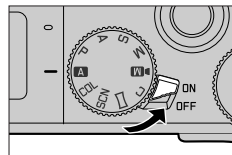

2 Press [MENU/SET] while the message is displayed

3 Press ▲▼ to select the language, and then [MENU/SET]

• The [Please set the clock] message appears.

4 Press [MENU/SET]

5 Press ◀▶ to select the items (year, month, day, hour, minute), and then ▲▼ to set

- Ⓐ : Home time
- : Destination time
- Ⓑ Style
- Ⓒ Display order
- Ⓓ Time display format

■ To set the display order or time display format

Select [Style] and then [MENU/SET] to display the setting screen for display order and time display format.

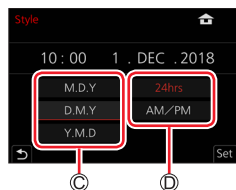
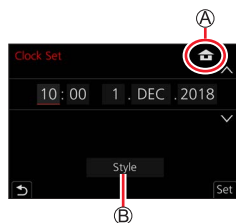

6 Press [MENU/SET]

- 7 When [The clock setting has been completed.] is displayed, press [MENU/SET]
- 8 When [Please set the home area] is displayed, press [MENU/SET]
- 9 Press ◀▶ to set your home area and then [MENU/SET]

- Ⓔ City or area name
- Ⓕ Current time
- Ⓖ Difference from GMT (Greenwich Mean Time)



■ Changing time settings

Perform steps **5** and **6** by selecting [Setup] menu → [Clock Set].

- For details about how to set the menu (→42)

Holding the Camera

Hold the camera firmly with both hands keeping your arms close to your body while standing with your feet slightly apart.

- To prevent dropping, be sure to attach the supplied strap and wrap it around your wrist.
- Do not block the flash, AF Assist Lamp, microphones, or speaker with your fingers or other objects.
- Make sure the camera does not move when you press the shutter button.
- Make sure your footing is stable and there is no danger of colliding with another person or object in the vicinity while taking pictures.

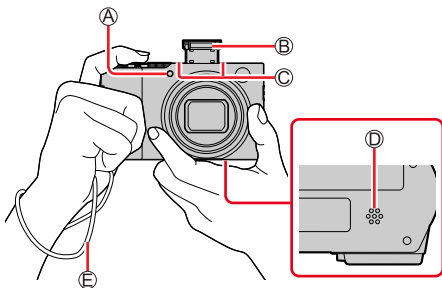

- Ⓐ AF Assist Lamp
- Ⓑ Flash
- Ⓒ Microphones
- Ⓓ Speaker
- Ⓔ Wrist strap

■ About the direction detect function

Pictures recorded with the camera held vertically can be automatically displayed in portrait orientation during playback. (Only when [Rotate Disp.] is set to [ON].)

- The direction detect function may not operate correctly if the pictures were taken with the camera pointing up or down.
- Videos, 4K photo series files recorded with the 4K Photo function, and pictures recorded in [Post Focus] cannot be displayed vertically.

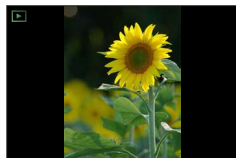

Buttons/Ring/Dials/Levers Used for Recording

Switching between viewfinder and monitor displays

1 Press [EVF]

- Ⓐ Eye Sensor
- Ⓑ [EVF] button

You can switch between monitor and viewfinder display.

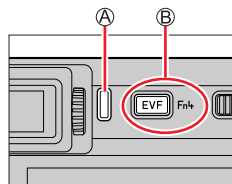

Automatic switching
between viewfinder and
monitor*

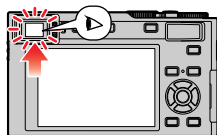

Viewfinder display*

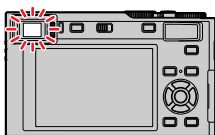

Monitor display

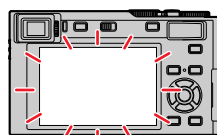

* When [Eye Sensor AF] in the [Custom] ([Focus / Release Shutter]) menu is set to [ON], the camera focuses automatically when the eye sensor is activated. Even when [Eye Sensor AF] is set and the camera automatically focuses, a beep will not sound.

■ Automatic switching between viewfinder and monitor displays

The eye sensor automatically switches the display to the viewfinder when your eye or an object moves close to the viewfinder. When the eye or object moves away from the viewfinder, the camera returns to monitor display.

■ About diopter adjustment

Rotate the diopter adjustment dial until you are able to clearly see the characters displayed in the viewfinder.

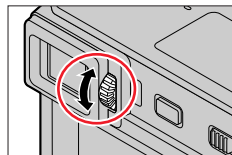

- If [EVF Display Speed] is set to [ECO 30fps] when the viewfinder is used, the camera can be operated for a longer period since battery drainage is reduced.
- The eye sensor may react differently depending on the shape of your eyeglasses, the way you hold the camera, or whether the eye sensor is exposed to strong light.
- During video playback or Slide Show, the eye sensor does not operate.

How to use the lens' zoom function

You can determine how much of a subject is to be captured / how large a subject is to be rendered by selecting the appropriate focal length, i.e. by zooming.

- You can also use the zoom function from the touch panel. (→142)
- For details about zoom types and use, refer to (→139).

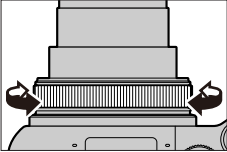
Zoom lever	Control ring
<p>1 Move the zoom lever</p> 	<p>1 Turn the control ring*</p>  <p>* You can perform zoom operation by assigning the [Zoom] setting to the control ring. (→49)</p>
<p>T side: Telephoto, enlarges the subject W side: Wide-angle, captures a larger area</p>	<p>Clockwise: Telephoto, enlarges the subject Counterclockwise: Wide-angle, captures a larger area</p>

- Do not touch the lens barrel during zooming.
- Focusing should be performed after zooming.
- The camera may make a rattling noise and vibrate when the zoom lever or control ring is operated. This is not a malfunction.

Taking pictures

1 Press the shutter button halfway (to the first pressure point) to focus on the subject

- (A) Focus display
(When focus is set correctly for the targeted subject: illuminated
When focus is not set correctly for the targeted subject: flashing)
- (B) Aperture value
(C) Shutter speed

- The descriptions on this page are based on the assumption that one of the Autofocus modes is being used. (→83)
- The aperture value and shutter speed are displayed. (If the aperture value and shutter speed are shown in red and flashing, this indicates over- or underexposure, unless you are using the flash.)

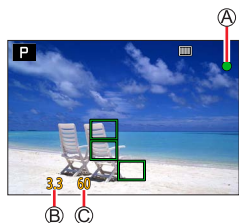

2 Press the shutter button fully (all the way) to take the picture



- Pictures can be taken only when the image is correctly focused as long as the [Focus/Release Priority] is set to [FOCUS].
- When [Monitor Display Speed] or [EVF Display Speed] (or both) is set to [ECO 30fps], Digital Zoom is not available.
- Even during menu operation or picture playback, if you press the shutter button halfway, you can instantly set the camera ready for recording.

■ Focusing range

The focusing range is displayed when zooming

- (A) Focusing range

- The focusing range is displayed in red when, after pressing the shutter button halfway, focusing is not successful/possible

The focusing range may change gradually depending on the zoom setting.

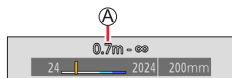

Recording videos

1 Press the video button to start recording

- Immediately release the video button after pressing it.

2 Press the video button again to end recording

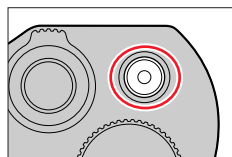

How to use the mode dial

1 Set to the desired recording mode

- Rotate the mode dial slowly to select the desired mode.

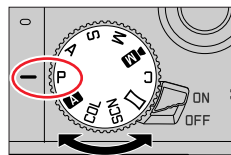

A	Snapshot Mode (→51) For taking pictures with extended automatic settings.
A	Snapshot Plus Mode (→51) For taking pictures with extended automatic settings while allowing certain manual adjustments.
P	Program Mode (→56) For taking pictures with automatic exposure control.
A	Aperture-Priority Mode (→57) The exposure is determined by the automatically controlled shutter speed, based on the manually set aperture value.
S	Shutter-Priority Mode (→58) The exposure is determined by the automatically controlled aperture value, based on the manually set shutter speed.
M	Manual Exposure Mode (→59) The exposure is determined by the manually set aperture value and shutter speed.
M	Creative Video Mode (→77) For recording videos with manual setting of aperture, shutter speed and ISO sensitivity. • You cannot take pictures.
C	Custom Mode (→81) For taking pictures with previously registered settings.
	Panorama Shot Mode (→64) For taking panorama pictures.
SCN	Scene Modes (→67) For taking pictures with automatic settings that match the subject.
COL	Creative Control Mode (→71) For taking pictures using different picture effects.

Control ring / Thumb dial

You can select menu items etc. by rotating the thumb dial.

You can use the control ring (A)/thumb dial (B) to change the settings for recording.

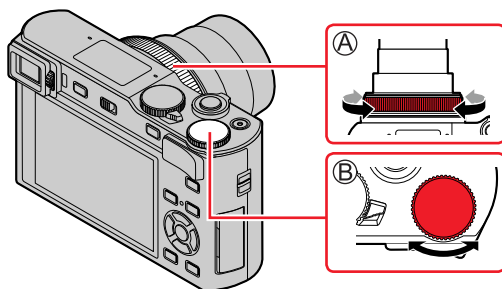

Following are the pre-assigned settings.

Mode dial	Control ring*1	Thumb dial
A	Step Zoom	—
P		P Program Shift
A		F Aperture setting
S		SS Shutter speed setting
M	F Aperture setting*2	SS Shutter speed setting*2
M	F Aperture setting*3 / SS Shutter speed setting*3	
	Picture effects change	
SCN	F Aperture setting*4 / SS Shutter speed setting*5	
COL	Picture effects change	

*1 When Manual Focus is set, the control ring is assigned to focus setting.

*2 Press **▲** to switch between shutter speed and aperture setting.

*3 When [Exposure Mode] is set to [A], [S], or [M], you can change the aperture value and shutter speed in the same way as when the mode dial is set to [A], [S], or [M].

*4 The operation is possible only when the Scene Mode is set to [Appetizing Food].

*5 The operation is possible only when the Scene Mode is set to [Artistic Nightscape].



The control ring/thumb dial can be used to change to your preferred settings. (→49)

Cursor buttons / [MENU/SET] button (Selecting/setting items)

Pressing the cursor buttons:
Use to select items or values etc.

Pressing [MENU/SET]:
Use this to confirm settings, etc.

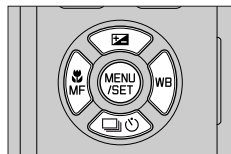

[DISP] button (Switching the display information)

1 Press [DISP] to switch the display

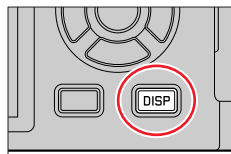

During recording

You can switch the viewfinder/monitor display method.

MENU → **⌘** [Custom] → **☑** [Monitor / Display] → [EVF/Monitor Disp. Set]
→ [EVF Disp. Set] or [Monitor Disp. Set]

[] (viewfinder style)

Scales down images slightly so that you can better review the composition of the images.

[] (monitor style)

Scales images to fill the entire screen so that you can see their details.

■ **[]** Viewfinder style display layout (Example of viewfinder style display)

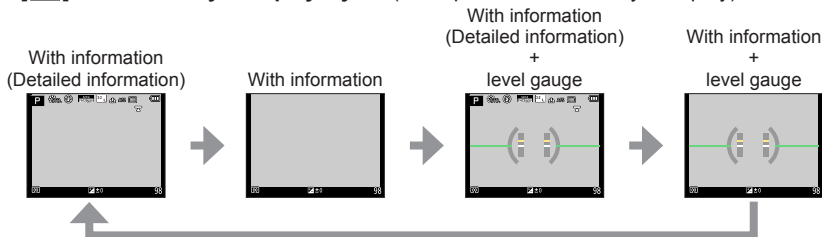

Buttons/Ring/Dials/Levers Used for Recording

■ [] Monitor style display layout (Example of monitor style display)

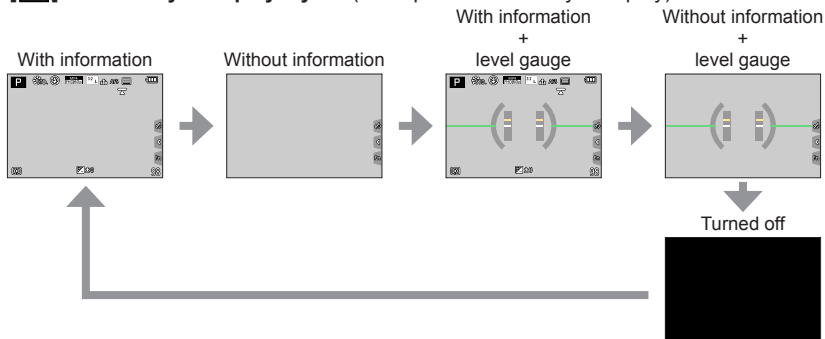

- With [Fn Button Set] in the [Custom] ([Operation]) menu, you can assign [EVF/Monitor Disp. Style] to a function button. Each time you press the assigned function button, the display style of the monitor or viewfinder ([]/[]), whichever is currently in use, will change.

■ Using the level gauge

The yellow line indicates the current angle. Correct the angle of the camera so that it matches the white line.

Tilting up or down

- In this case, it is facing upwards.

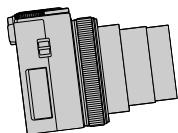

Tilting left or right

- In this case, it is tilted to the right.

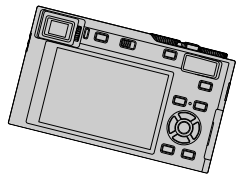

- When the camera is level or only very slightly tilted, the level gauge will turn green.

- Even when no tilt is indicated, there may be an error of about ± 1 degree.
- The level gauge may not be displayed correctly or the direction detect function may not operate correctly if the pictures are taken with the camera pointing sharply up or down.

Buttons/Ring/Dials/Levers Used for Recording

During playback

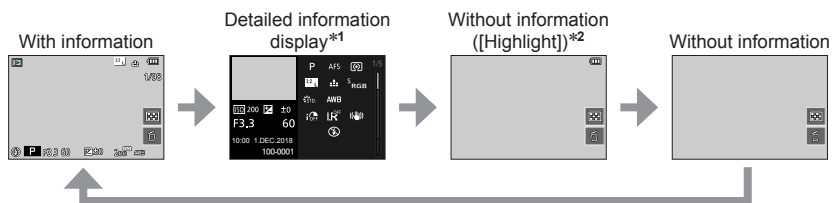

*1 Press ▲▼ to switch between the following display modes:

- Detailed information display
- Histogram display
- Photo style, Highlight shadow display
- White balance display
- Lens information display

*2 This screen is displayed only when [Highlight] in the [Custom] ([Monitor / Display]) menu is set to [ON].

Touch screen operations

Touch

Touch and release the monitor screen.



Drag

Touch and slide your finger across the monitor screen.



Pinch (spread/pinch)

On the monitor screen, spread 2 fingers to zoom in, and pinch 2 fingers to zoom out.

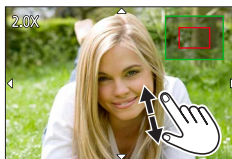

- Touch the screen with a clean and dry finger.
- If you use a commercially available monitor protection foil, please follow the instructions that accompany it. (Some monitor protection foils may impair visibility or operability.)
- The touch screen may not function normally in the following cases.
 - When touched by a gloved hand
 - When the monitor surface is wet

Focusing on the subject at the touched position (Touch AF, Touch Shutter)

Recording modes: 



1 Touch []



2 Touch the desired icon

- The icon switches every time you touch one.



 (Touch AF)	Focuses on the subject detail you touch.*
 (Touch shutter)	Focuses on the touched subject detail and releases the shutter.*
 (OFF)	Touch AF and Touch Shutter are disabled.

*When [Touch AF] in [Touch Settings] of the [Custom] ([Operation]) menu is set to [AF+AE], the focus and exposure settings are optimized for the touched subject detail. (→95)

3 (When settings other than OFF are selected) Touch the subject

For details on changing the position and size of the AF area when the [] (Touch AF) is set, refer to (→91).



- If shooting with the touch shutter function fails, the AF area turns red and disappears.

Adjusting the exposure based on the touched subject detail ([Touch AE])

Recording modes: **A A P A S M M SCN COL**

When e.g. the face of the subject is darker than you would like, you can brighten the exposure by basing it on the face.

1 Touch [**<**]

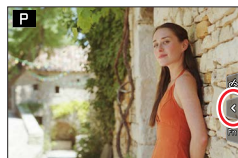

2 Touch [**AE**]

- The setting screen for the brightness optimization position is displayed.
- [Metering Mode] is set to [**AE**], which is used exclusively for [Touch AE].

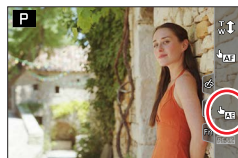

3 Touch the subject detail you want to optimize the brightness for

- Touching [Reset] will bring the brightness optimization position back to the center.

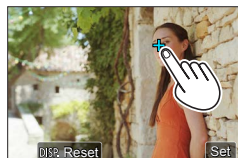

4 Touch [Set]

■ Canceling the [Touch AE] function

Touch [**AE**]

- This function is not available in the following cases:
 - When using the Digital Zoom
 - When recording with [High Speed Video]
 - When recording using [4K Live Cropping]
 - When [Touch AF] in [Touch Settings] of the [Custom] ([Operation]) menu has been set to [AF+AE]

Menu Control

Menu settings can be made either by button or touch operation.

1 Press [MENU/SET] to bring up the menu

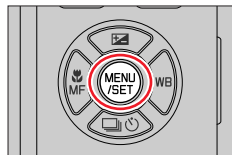

2 To switch between menu tabs

Ⓐ Menu tabs

① Press ◀

② Press ▲ ▼ to select a tab such as [🔧]

③ Press [MENU/SET]

— With touch screen operations —

Touch a tab, such as [🔧]

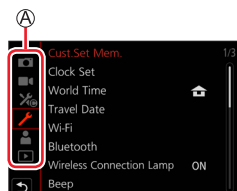

[Rec] (→165)	For settings such as aspect ratio, number of pixels, 4K Photo, etc.
[Motion Picture] (→180)	This menu lets you set the [Rec Quality], and other aspects for video recording.
[Custom] (→182)	Operation of the camera, such as displaying of the screen and button operations, can be set up according to your preferences.
[Setup] (→196)	For settings that make usage more convenient, such as the changing the clock settings and beep tone. You can also perform Wi-Fi/Bluetooth function-related settings.
[My Menu] (→206)	Allows you to register frequently used menus.
[Playback] (→207)	Allows you to perform settings for playback and editing pictures.

- Menus displayed in each recording mode (→164)

3 Press ▲▼ to select the menu item and then [MENU/SET]

- Ⓑ Item
- Ⓒ Page

- You can switch to the next page by rotating the thumb dial.

— With touch screen operations —

Touch the menu item

- You can switch pages by touching Ⓒ on the right side of the display.

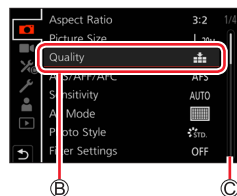

4 Press ▲▼ to select the setting and then [MENU/SET]

- Ⓓ Selected setting
- Ⓔ Settings

- The setting methods vary depending on the menu item.

— With touch screen operations —

Touch the setting to set

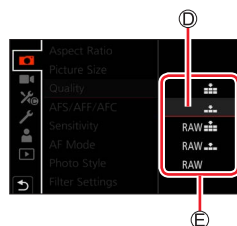

5 Press [Q/M] (→) repeatedly until the recording or playback screen reappears

- During recording, the menu screen can also be exited by pressing the shutter button halfway.

— With touch screen operations —

Touch (→)

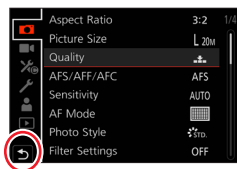

- You can display an explanation on the menu by pressing the [DISP] while you select a menu item or setting.
- The menu items that cannot be set are grayed out. In some setting conditions, the reason the setting is disabled is displayed when you press [MENU/SET] if you select a grayed-out menu item.

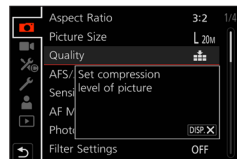

Quick Menu

You can easily call up some of the menu items and set them during recording.

1 Press [QM|↵]

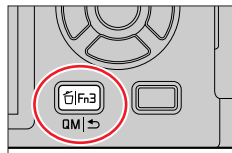

2 Rotate the thumb dial to select a menu item, and press ▼ or ▲

- The menu item can also be selected by pressing ◀▶.

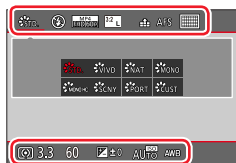

3 Rotate the thumb dial to select the setting

- The setting can also be selected with ◀▶.

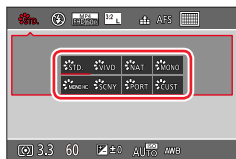

4 Press [QM|↵] to close the Quick Menu

- Some items or settings cannot be selected depending on the mode or display style the camera is in.

Customizing the Quick Menu

Up to 15 items can be assigned to the Quick Menu.

MENU → **⌘** [Custom] → **⚙** [Operation] → [Q.MENU] → [CUSTOM]

- 1** After pressing [QM|↵], press ▼ to select [Q⌘], and then [MENU/SET]

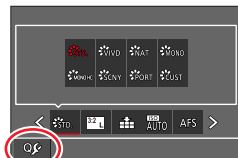

- 2** Press ▲▼◀▶ to select the menu item in the top row and then [MENU/SET]

(A) Top row: Items that can be set

(B) Bottom row: Items assigned to the Quick Menu

- Items that are displayed in light gray in the top row are already assigned to the Quick Menu.

- 3** Press ◀▶ to select the empty space in the bottom row and then [MENU/SET]

- You can also assign a menu item by dragging it from the top row to the bottom row.
- If there is no empty space in the bottom row, assigning a new item replaces the one formerly in the position of the new item.
- To cancel the setting, move to the bottom row by pressing ▼ and select an item to cancel, and then press [MENU/SET].

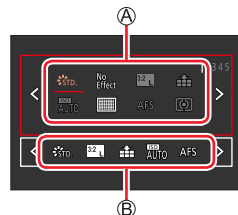

- 4** Press [QM|↵]

- It will return to screen of step 1. Press [MENU/SET] to switch to the recording screen.

Assigning Frequently used Functions to the Buttons

(Function buttons)

You can assign frequently-used functions to particular buttons ([Fn1] - [Fn4]) or icons displayed on the monitor screen ([Fn5] - [Fn9]).

1 Set the menu

MENU →  [Custom] →  [Operation] → [Fn Button Set]

Settings: [Setting in REC mode] / [Setting in PLAY mode]

2 Press ▲▼ to select the function button you want to assign a function to and then [MENU/SET]

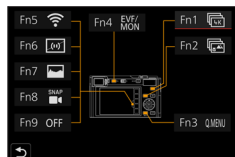

3 Press ▲▼ to select the function you want to assign and then [MENU/SET]

- For details on the functions that can be assigned in [Setting in REC mode], refer to (→47).
- For details on the functions that can be assigned in [Setting in PLAY mode], refer to (→48).

■ Rapidly assigning functions

The screen displayed in Step 3 can be displayed by holding a function button ([Fn1] to [Fn4]) for 2 seconds.

- Certain functions cannot be assigned to some function buttons.
- The function assigned to a function button may not work in some modes or on some display screens.

Assigning Frequently used Functions to the Buttons (Function buttons)

Using the function buttons during recording

Press the function button to use the assigned function.

■ Using the touch function buttons

- ① Touch [Fn]
- ② Touch [Fn5], [Fn6], [Fn7], [Fn8] or [Fn9]



■ Functions that can be assigned in [Setting in REC mode]

- | | | |
|---------------------------------|-------------------------|-----------------------------|
| • [4K Photo Mode]: [Fn1]*1 | • [Quality] | • [Motion Pic. Rec Quality] |
| • [Post Focus]: [Fn2]*1 | • [Sensitivity] | • [Silent Mode] |
| • [Wi-Fi]: [Fn5]*1 | • [AF Mode] | • [Peaking] |
| • [Q.MENU]: [Fn3]*1 | • [AFS/AFF/AFC] | • [Histogram]: [Fn7]*1 |
| • [Video Record] | • [Metering Mode] | • [Guide Line] |
| • [EVF/Monitor Switch]: [Fn4]*1 | • [Bracket] | • [Zebra Pattern] |
| • [EVF/Monitor Disp. Style] | • [Highlight Shadow] | • [Monochrome Live View] |
| • [AF/AE LOCK] | • [i.Dynamic] | • [Constant Preview] |
| • [AF-ON] | • [i.Resolution] | • [Rec Area] |
| • [Preview] | • [Min. Shtr Speed] | • [Zoom lever] |
| • [One Push AE] | • [HDR] | • [Exposure Comp.] |
| • [Touch AE] | • [Shutter Type] | • [White Balance] |
| • [Level Gauge]: [Fn6]*1 | • [Flash Mode] | • [Focus Mode] |
| • [Focus Area Set] | • [Flash Adjust.] | • [Drive Mode] |
| • [Operation Lock] | • [i.Zoom] | • [Rec / Playback Switch] |
| • [Photo Style] | • [Digital Zoom] | • [Off]*2: [Fn9]*1 |
| • [Filter Effect] | • [Stabilizer] | |
| • [Aspect Ratio] | • [4K Live Cropping] | |
| • [Picture Size] | • [Snap Movie]: [Fn8]*1 | |

*1 Function button settings at the time of purchase.

*2 No function is assigned to function buttons.

Assigning Frequently used Functions to the Buttons (Function buttons)

- When [Video Record] is assigned to a function button, you can start and stop recording videos the same way as you would by pressing the video button.
- When [Focus Area Set] is assigned to a function button, you can display the AF area or the MF Assist position setting screen.
- When [Operation Lock] is assigned to a function button, you can disable the operations that were set using [Operation Lock Setting] in the [Custom] ([Operation]) menu. To cancel the lock, press the function button to which [Operation Lock] is assigned again.
- When [Rec / Playback Switch] is assigned to a function button, you can switch between recording and playback modes.
- To restore the default function button settings, select [Restore to Default] in step **3** (→46).
- If the screen displays  or similar, the displayed operation will be performed instead of the function assigned to the function buttons by [Fn Button Set].

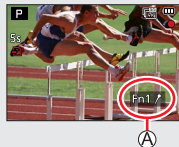

Using the function buttons during playback

You can directly set an assigned function to a selected image by pressing the function button during playback.

Example: When [Fn2] is set to [Rating★3]

1 Press  to select the picture

2 Press [Fn2], and then set the picture as [Rating★3]

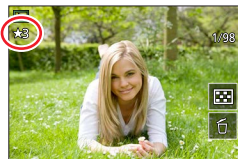

■ Functions that can be assigned in [Setting in PLAY mode]

- The following functions can be assigned to the buttons [Fn1], [Fn2] or [Fn4].

- | | | |
|--|--|---|
| <ul style="list-style-type: none"> • [Wi-Fi]: [Fn1]*1 • [EVF/Monitor Switch]: [Fn4]*1 • [Rec / Playback Switch] • [4K PHOTO Play] • [Delete Single] | <ul style="list-style-type: none"> • [Protect] • [Rating★1] • [Rating★2] • [Rating★3]: [Fn2]*1 • [Rating★4] | <ul style="list-style-type: none"> • [Rating★5] • [RAW Processing] • [4K PHOTO Bulk Saving] • [Off]*2 |
|--|--|---|

*1 Function button settings at the time of purchase.

*2 No function is assigned to function buttons.

- To restore the default function button settings, select [Restore to Default] in step **3** (→46).

Changing the Settings Assigned to the Control Ring/ Thumb Dial

















Recording modes:   **P** **A** **S** **M**    

Changes the settings assigned to the control ring/thumb dial.

MENU →  **[Custom]** →  **[Operation]** → **[Ring/Dial Set]**

Settings:  (control ring) /  (thumb dial)

1 Use to select the setting and then **[MENU/SET]**

 [Normal]	 [Photo Style]
 [Zoom]*	 [Filter Effect]
 [Step Zoom]*	 [Aspect Ratio]
 [Exposure Comp.]	 [Highlight Shadow]
 [Sensitivity]	 [i.Dynamic]
 [White Balance]	 [i.Resolution]
 [AF Mode]	 [Flash Mode]
 [Focus Mode]	 [Flash Adjust.]
 [Drive Mode]	[OFF] [Not Set]*

* Items that can only be set to the control ring

- To return to the default setting, select [Normal].
- If you do not want to use the control ring, select [Not Set].
- Under [Highlight Shadow], both the control ring and thumb dial are used.
If [Highlight Shadow] is assigned to the control ring (or thumb dial), [Highlight Shadow] will also be assigned to the thumb dial (or control ring).

- The assigned function setting applies to all the recording modes.
However, the assigned function may not operate when combined with certain recording modes.

Entering Text

Follow the steps below when the text entry screen is displayed.

1 Use ▲▼◀▶ to select characters

2 Press [MENU/SET] several times until the desired character is displayed

- []: Enter a blank.

■ To change the character type

- Press [DISP]
- Use ▲▼◀▶ to select [] and press [MENU/SET]

■ To continue entering characters

- Use ▲▼◀▶ to select [] and press [MENU/SET]
- Move the zoom lever towards the T side
- Rotate the thumb dial counterclockwise.

■ To edit text

- ① Use ▲▼◀▶ to select [] [] and press [MENU/SET]. Then, move the cursor to the character to edit
 - You can also use the zoom lever or thumb dial to reposition the cursor.
- ② Use ▲▼◀▶ to select [Delete] and press [MENU/SET]
- ③ Use ▲▼◀▶ to select the correct character, and press [MENU/SET]



3 When you are finished entering text, use ▲▼◀▶ to select [Set] and press [MENU/SET]

- A maximum of 30 characters can be entered (maximum of 9 characters when setting names in [Face Recog.]).
- A maximum of 15 characters can be entered for [], [], [], [] and [] (maximum of 6 characters when setting names in [Face Recog.]).

Snapshot Modes

Recording modes:  

These modes are recommended for those who prefer a point and shoot style, while relying on the camera to automatically select settings to match the subject and recording environment.

1 Set the mode dial to

- At the time of purchase, the mode is set to Snapshot Plus Mode.

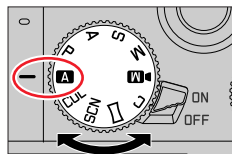





2 Point the camera at the subject

- When the camera identifies the optimal scene mode for the targeted subject, the icon for the respective scene mode turns blue for 2 seconds and then changes to the gray indication. (Automatic Scene Detection)



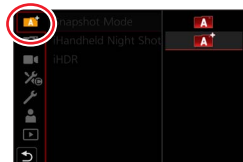

■ Switching between Snapshot Plus Mode and Snapshot Mode

- Select the Snapshot Mode tab
- Press  to open the Snapshot Mode menu
- Select [Snapshot Mode] in the [Snapshot Mode] menu
- Press   to select  or  and then [MENU/SET]





It is also possible to display the selection screen by touching the recording mode icon in recording screen.



 allows you to adjust some settings such as the exposure and color tone while also using  for other settings so that you can record pictures more suited to your preferences.

(○: Available, -: Not available)

	 Snapshot Plus Mode	 Snapshot Mode
Setting the color tone	○	-
Setting the exposure	○	-
Defocus control function	○	-
Menus that can be set	Many	Few

Autofocus, Face/Eye Detection, and Face Recognition

[AF Mode] is automatically set to [i:👤]. When you touch the subject detail you want to be rendered sharply, the camera switches to [i:👤] and the AF tracking function starts operating.

- You can also switch to [i:👤] by pressing [MENU/SET], going to the [Rec] menu, then going to the [AF Mode] menu and selecting [i:👤] (tracking). Aim the AF tracking area at the subject detail you want to be rendered sharply and press the shutter button halfway to initiate the AF tracking function.
- When [Face Recog.] is set to [ON] and if the camera recognizes a face similar to a registered face, [R] is displayed on the upper right corner of the [i:👤], [i:👤], and [i:😊] icons.

Flash

When the flash is open, the camera will automatically be set to [i:👤], [i:👤] (Auto/Red-Eye Reduction), [i:👤], or [i:👤], depending on the type of subject and ambient brightness.

- When [i:👤] or [i:👤] is displayed, the [Red-Eye Removal] function is activated to automatically detect red-eye and correct the picture data.
- When [i:👤] or [i:👤] is selected, the shutter speed may be reduced.

Automatic Scene Detection

When taking pictures

i:👤 [i-Portrait]	i:👤 [i-Scenery]	i:🌸 [i-Macro]
i:👤 [i-Night Portrait]*1	i:👤 [i-Night Scenery]	i:👤 [i-Handheld Night Shot]*2
i:🍷 [i-Food]	i:😊 [i-Baby]*3	i:🌅 [i-Sunset]
[A] / [A] When the subject does not correspond to any of the above		

When recording videos

i:👤 [i-Portrait]	i:👤 [i-Scenery]	i:👤 [i-Low Light]	i:🌸 [i-Macro]
[A] / [A] When the subject does not correspond to any of the above			

*1 Displayed only when using flash.

*2 When [i-Handheld Night Shot] is [ON].

*3 When children (that are registered in the camera with Face Recognition) under 3 years old are recognized.

Snapshot Modes

- When the camera identifies [i] as the optimal scene mode and if it determines that camera shake is reduced by the use of a tripod or by other means, a shutter speed slower than usual is selected. After pressing the shutter button, do not move the camera while recording.
- When recording 4K photos or when recording using [Post Focus], Scene Detection works the same way as when recording videos.

● Depending on recording conditions, different scenes may be determined for the same subject.



About Backlight Compensation

Backlight compensation is automatically activated in Snapshot Plus Mode or Snapshot Mode. Backlight is a condition where a light shines from behind a subject. In backlighting, parts of the subject would appear darker than you may want them to be rendered, so the camera will automatically attempt to correct this by increasing the overall brightness.

[Snapshot Mode] menu

Taking pictures handholding the camera ([iHandheld Night Shot])

Recording modes:

If a night scene is detected while the camera is being handheld, [iHandheld Night Shot] is selected automatically to record a picture with less camera shake and less noise without using a tripod by combining a number of serial shots.

MENU → / **[Snapshot Mode]** → **[iHandheld Night Shot]**

Settings: **[ON]** / **[OFF]**

- The recorded area is slightly smaller than usual.
- After the shutter button has been pressed, do not move the camera during the exposure series.
- The flash is fixed to the (Forced Flash Off) setting.
- This function will not work for pictures while a video is being recorded.
- This function is not available in the following cases:
 - When using [Burst]
 - When recording 4K photos
 - When recording using [Post Focus]
 - When recording using [Bracket]
 - When [Quality] is set to [RAW], [RAW] or [RAW]
 - When using [Time Lapse Shot]
 - When [Auto Shooting] of [Stop Motion Animation] is set to [ON]

Combining several photos into a single picture with rich gradation ([iHDR])

Recording modes:  

When there is, for example, strong contrast between the background and the subject, [iHDR] records multiple photos with differing exposures and combines them to create a single picture rich in gradation.

[iHDR] is activated when required. When activated, [iHDR] will be displayed on the monitor screen.

MENU → **A** / **A** [Snapshot Mode] → [iHDR]

Settings: [ON] / [OFF]

- The recorded area is slightly smaller than usual.
- After the shutter button has been pressed, do not move the camera during the exposure series.
- Since a series of photos are combined after they have been recorded, it will be a few moments before you can record another one.
- In the case of composition from a photo series, afterimages may appear if the subject was moving.
- This function will not work for pictures while videos are being recorded.
- This function is not available in the following cases:
 - When recording using the flash
 - When using [Burst]
 - When recording 4K photos
 - When recording using [Post Focus]
 - When recording using [Bracket]
 - When [Quality] is set to [RAW], [RAW.L] or [RAW]
 - When using [Time Lapse Shot]
 - When [Auto Shooting] of [Stop Motion Animation] is set to [ON]

Setting coloring

Recording mode: 

1 Press **▶** to display the setting screen

2 Rotate the thumb dial to adjust the color

- Press [MENU/SET] to return to the recording screen.
- The color setting will return to the default level (center point) when the camera is turned off or it is switched to another recording mode.
- With touch screen operations (→55)



Setting brightness (exposure)/blurriness of the background (Defocus control function)

Recording mode: 

1 Press **▲** to display the setting screen

- The brightness (exposure) operation screen is displayed. Press [Fn1] to operate the defocus control, and then press it again to finish the operation.

2 Rotate the thumb dial to set



- Press [MENU/SET] to return to the recording screen.

When setting the brightness (exposure)

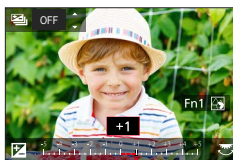
- Press **▲▼** to set the Exposure Bracket. (→129)







When setting the background defocusing

- Pressing [Q/M]  will cancel the setting.
- The Autofocus Mode is set to . The position of the AF area can be set by touching the screen. (Its size cannot be changed)



■ With touch screen operations

- Touch 
- Touch the item you want to set
 - : Coloring
 - : Degree of defocusing
 - : Brightness
- Drag the slide bar or exposure meter to set
 - Press [MENU/SET] to return to the recording screen.



Taking Pictures Using the Exposure Control Modes P, A, S, and M

Program exposure mode

Recording mode: **P**

The camera automatically sets the shutter speed and the aperture value according to the brightness of the subject.

- 1 Set the mode dial to [P]
- 2 Press the shutter button halfway
 - If the aperture value and shutter speed flash red, you do not have the correct exposure.
- 3 While the numeric values are displayed (approximately 10 seconds), rotate the thumb dial to change the values, i.e. to use the Program Shift function

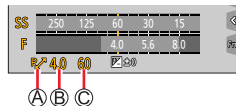

(A) Program Shift indication

(B) Aperture value

(C) Shutter speed

- The operation can also be performed by rotating the control ring.
- To cancel Program Shift, either turn off the camera or rotate the thumb dial until the Program Shift indication turns off.
- Program Shift can easily be canceled by setting a function button to [One Push AE]. (→46, 63)

About Program Shift

The function for maintaining the same exposure (brightness) while changing the aperture value and shutter speed combination is called "Program Shift".

- Program Shift cannot be used in the following cases:
 - When recording using the flash
 - When recording 4K photos
 - When recording using [Post Focus]
 - When ISO sensitivity is set to [H]ISO

Taking Pictures Using the Exposure Control Modes **P**, **A**, **S**, and **M****Aperture Priority Exposure Mode**Recording mode: **A**

Set the aperture value to a higher number if you want a larger in-focus area (in front of and behind the focused subject), or to a lower number for the opposite.

1 Set the mode dial to [A]**2 Rotate the thumb dial to set the aperture value**

- The operation can also be performed by rotating the control ring.

- Ⓐ Aperture value
- Ⓑ Exposure setting balance

Aperture values that can be set*	Shutter speed automatic setting range (seconds)
F3.3 - F8.0	60 - 1/2000 (When the mechanical shutter is used) 1 - 1/16000 (When the electronic shutter is used)

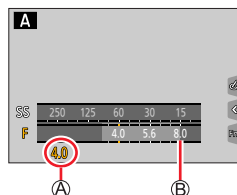

* You may not be able to select some values depending on the zoom lens' focal length setting.

- The effect of the aperture value you have set is not applied to the monitor image. To check the effect on the monitor image, use Preview Mode. (→62)
- The brightness of the monitor image may vary from the actual recorded photo. Check its brightness using the playback screen.
- When you adjust the aperture value, an exposure setting balance is displayed. If the aperture value is shown in red, you do not have an appropriate exposure.
- If the correct exposure is not achieved when you press the shutter button halfway, the numeric values of the shutter speed is displayed in flashing red.

Taking Pictures Using the Exposure Control Modes **P**, **A**, **S**, and **M****Shutter-Priority Exposure Mode**Recording mode: **S**

Set a faster shutter speed if you want to take a sharp photo of a moving subject, or a slower speed if you want to create e.g. subject blur to emphasize a movement.

1 Set the mode dial to [S]**2 Rotate the thumb dial to set the shutter speed**

- The operation can also be performed by rotating the control ring.

- Ⓐ Shutter speed
- Ⓑ Exposure setting balance

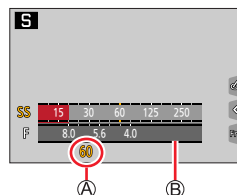

Shutter speeds that can be set (seconds)	Aperture value automatic setting range
60 - 1/2000 (When the mechanical shutter is used)	F3.3 - F8.0
1 - 1/16000 (When the electronic shutter is used)	

- The effect of the shutter speed you have set is not applied to the monitor image. To check the effect on the monitor image, use Preview Mode. (→62)
- The brightness of the monitor image may vary from the actual recorded photo. Check its brightness using the playback screen.
- When you adjust the shutter speed, an exposure setting balance is displayed. If the shutter speed is shown in red, you do not have an appropriate exposure.
- If the correct exposure is not achieved when you press the shutter button halfway, the numeric value of the aperture is displayed in flashing red.

Taking Pictures Using the Exposure Control Modes **[P]**, **[A]**, **[S]**, and **[M]**

Manual Exposure Mode

Recording mode: **[M]**

This mode allows you to determine the exposure by manually setting both shutter speed and aperture value. The exposure setting balance scale appears at the bottom of the screen to indicate the over-/under-/correct exposure resulting from the respective settings.

1 Set the mode dial to **[M]**

2 Turn the control ring to set the aperture value, and the thumb dial to set the shutter speed

- You can switch the setting operation of control ring and thumb dial by pressing **▲**.

- Ⓐ Aperture value
- Ⓑ Shutter speed
- Ⓒ Exposure deviation indication
- Ⓓ Exposure setting balance

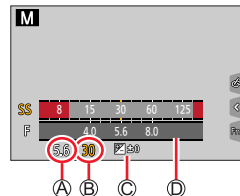

Aperture values that can be set*	Shutter speeds that can be set (seconds)
F3.3 - F8.0	T (Time), 60 - 1/2000 (When the mechanical shutter is used) 1 - 1/16000 (When the electronic shutter is used)

* You may not be able to select some values depending on the zoom lens' focal length setting.



Optimizing the ISO sensitivity for the aperture value and shutter speed

When the ISO sensitivity is set to **[AUTO]**, the camera sets it automatically to ensure an appropriate exposure for the respective aperture and shutter speed settings.

- Depending on recording conditions, an appropriate exposure may only be achieved by using a higher ISO sensitivity, or not at all with the respective aperture and shutter speed settings.



Light balance (approximation)

	Shows pictures with standard brightness (appropriate exposure).
	Shows brighter pictures. For the appropriate exposure, either use a faster shutter speed or increase the aperture value.
	Shows darker pictures. For the appropriate exposure, either use a slower shutter speed or reduce the aperture value.

Taking Pictures Using the Exposure Control Modes **P**, **A**, **S**, and **M**

- The effect of the aperture value and shutter speed you have set is not applied to the monitor image. To check the effect on the monitor image, use Preview Mode. (→62)
- The brightness of the monitor image may vary from the actual recorded photo. Check its brightness using the playback screen.
- When you adjust the aperture value and shutter speed, an exposure setting balance is displayed. If aperture and shutter speed are shown in red, you do not have an appropriate exposure.
- If the correct exposure is not achieved when you press the shutter button halfway, the numeric values of the aperture and shutter speed are displayed in flashing red.

Taking Pictures Using the Exposure Control Modes **[P]**, **[A]**, **[S]**, and **[M]****About [T] (Time)** (Approximately up to 120 seconds)

If you set the shutter speed to [T], the shutter stays open when the shutter button is pressed fully. The shutter closes when you press the shutter button again. Use this function when you want to keep the shutter open for an extended period, for example, to record pictures of fireworks or night scenes.



- When the shutter speed is set to [T] (time), we recommend using a tripod and taking pictures remotely by connecting the camera to a smartphone via Wi-Fi connection to prevent camera shake. [B] (Bulb) is also available when connected via Bluetooth. (→236, 238)
- When you take pictures with the shutter speed set to T (time), the pictures may have higher noise levels. If you want to suppress noise, we recommend setting [Long Shtr NR] to [ON] in the [Rec] menu. (→175)

- This function is not available in the following cases:
 - When recording using the flash (Only when [Flash Synchro] is set to [2ND])
 - When recording 4K photos
 - When recording using [Post Focus]
 - When recording using [Bracket]
 - When [HDR] is set to [ON]
 - When using the electronic shutter
 - When [Silent Mode] is set to [ON]
 - When using [Time Lapse Shot]
 - When [Auto Shooting] of [Stop Motion Animation] is set to [ON]

Taking Pictures Using the Exposure Control Modes **P**, **A**, **S**, and **M**

Checking the effects of the aperture value and shutter speed settings (Preview Mode)

Recording modes: **A** **A** **P** **A** **S** **M** **M** **M** **SCN** **COL**

- **Checking the effect of the selected aperture value:** This enables you to check the depth of field (focus range).
- **Checking the effect of the selected shutter speed:** This allows you to check motion sharpness in a scene.

Preparations

- Assign [Preview] to the function button (→46)

The following step is an example of assigning [Preview] to the [Fn3] button.

1 Press [Fn3] to switch the confirmation screen

- Every time you press [Fn3], the screen switches.

Normal recording screen



Aperture effect preview screen

Aperture effect: ○
Shutter speed effect: –

Shutter speed effect preview screen

Aperture effect: ○
Shutter speed effect: ○

Depth of field characteristics

Recording conditions	Aperture value	Small	Large
	Focal length	longer	shorter
	Distance to a subject	closer	farther
Depth of field (Focus range)		Shallow (narrow) Example: To deliberately blur the background	Deep (wide) Example: To render more of the subject in focus

Taking Pictures Using the Exposure Control Modes **P**, **A**, **S**, and **M**

- You can take a picture even when Preview Mode is activated.
- The range in which you can check the effect of a selected shutter speed is between 8 seconds and 1/16000 seconds.
- This mode cannot be used with [4K] (4K Pre-Burst) of 4K Photo.

Easily set aperture value / shutter speed for suitable exposure (One Push AE)

Recording modes: **A** **A** **P** **A** **S** **M** **M** **SCN** **COL**

When the exposure setting is too bright or too dark, you can use one push AE to achieve a suitable exposure setting.



How to tell if the exposure is not adequate

A Flashes red

- If the aperture values and shutter speed flash red when the shutter button is pressed halfway.
- If the Exposure Deviation Indication (→59) is anything other than [] when in Manual Exposure Mode.

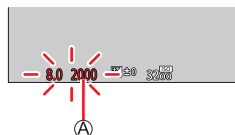

Preparations

- Assign [One Push AE] to the function button (→46)

1 (When exposure is not adequate) Press the function button

B Change to an appropriate exposure

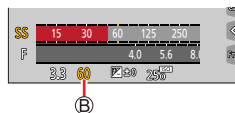

- In the following cases, a suitable exposure cannot be set.
 - When the subject is extremely dark and it is not possible to achieve adequate exposure by changing the aperture value or shutter speed
 - When recording using the flash
 - Preview Mode

Recording panorama pictures

Recording mode: 

Consecutive photos taken while the camera is moved are combined to form a panorama.

- 1** Set the mode dial to 
- 2** Press the shutter button halfway to focus
- 3** Press the shutter button fully and pan the camera in a small circular motion to the recording direction to start recording

Ⓐ Horizontal/vertical guide line

Ⓑ Recording direction and progress status (approximate)

Taking pictures from left to right

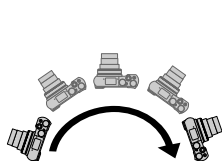

Image size: [STANDARD]

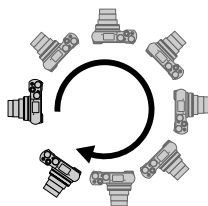
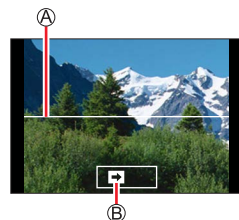

Image size: [WIDE]



- Pan the camera at a constant speed.

- You may not be able to take pictures successfully if you move the camera too quickly or too slowly.

- 4** Press the shutter button fully again to end recording

- You can also end recording if you stop panning the camera while taking pictures.
- Recording can also be ended by moving the camera to the end of the guide.

Recording panorama pictures

■ Changing the recording direction and panning range of panorama pictures

MENU →  **[Panorama Shot]** → **[Direction]** / **[Picture Size]**

[Direction] Sets the recording direction.

[Picture Size] Sets the panning range.
[STANDARD] / **[WIDE]**

- The number of recording pixels per horizontal line and vertical line of a panorama picture varies depending on the panning range, recording direction and number of stitched photos. The maximum number of recording pixels is as follows:

Panning range	Recording direction	Horizontal resolution	Vertical resolution
[STANDARD]	Horizontal	8176 pixels	1920 pixels
	Vertical	2560 pixels	7680 pixels
[WIDE]	Horizontal	8176 pixels	960 pixels
	Vertical	1280 pixels	7680 pixels



Tips

Pan the camera in the recording direction as steadily as possible.

(If the camera shakes too much, it may not be able to take pictures or may end up creating a narrower panorama picture.)







- Ⓐ Pan the camera to a point slightly ahead of the point that you want to take. (However, the last frame is not recorded to the end.)

Recording panorama pictures

■ About panorama picture playback

Pressing ▲ will start scrolling playback automatically in the same direction as the recording.

- The following operations can be performed during scrolling playback.

		Start panorama playback / Pause*
		Stop



*When the playback is paused, you can scroll forwards and backwards by dragging the screen. When the scroll bar is touched, the playback position jumps to the touched position.

- The zoom position is fixed to the widest focal length.
- The focus, exposure and White Balance are all fixed to optimal values for the first picture. If the focusing or brightness of the recorded pictures as part of a panorama picture differ significantly from the first one, the panorama picture as a whole (when all pictures are stitched together) may not have consistent focus and brightness.
- Since several photos are stitched together to create a panorama picture, some subjects may be distorted or the joining portions of successively taken photos that are stitched may be noticeable.
- Panorama pictures may not be created or photos may not be recorded properly in the case of the following subjects or in case of following recording conditions:
 - Subjects that have large single-color areas or repetitive patterns (sky, beach, etc.)
 - Moving subjects (persons, pets, vehicles, waves, or flowers swaying in the wind, etc.)
 - Subjects whose colors or patterns change quickly (such as an image appearing on a display)
 - Dark locations
 - Locations with a flickering light source (fluorescent lamp, candle light, etc.)

Scene Modes

Recording mode: 

If you select a scene mode suiting the subject and the recording conditions with reference to the example images, the camera will set optimal exposure, color, and focus, allowing you to record in a manner appropriate to the scene.

1 Set the mode dial to [SCN]

2 Press ◀▶ to select the scene mode

- The scene mode can also be selected by dragging an example image or the slide bar.

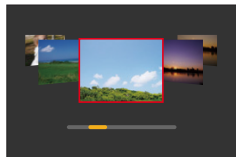

3 Press [MENU/SET]



It is also possible to display the selection screen by touching the Recording mode icon in the recording screen.



- Depending on the scene mode, the recording screen may seem as if frames are missed.
- To change the scene mode, select [Scene Switch] in the [Scene Guide] menu, and then press [MENU/SET]. You can return to step 2.
- Some of the recording menu items cannot be set in Scene Mode because the camera automatically adjusts the settings to the optimal values.
- Although White Balance is fixed to [AWB] for certain scene modes, you can fine tune the White Balance or use White Balance bracketing by pressing the cursor button ▶ on the recording screen.

Types of Scene Modes



Displaying the description of each scene mode and recording tips

Press [DISP] while the scene selection screen is displayed

- When it is set to the guide display, detailed explanations and tips for each scene are displayed.

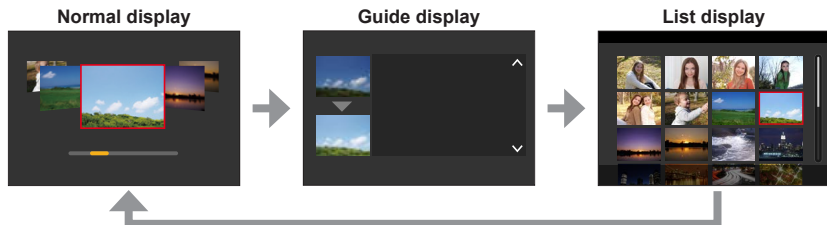

1: [Clear Portrait]

2: [Silky Skin]

- If a part of the background etc. is a color close to skin color, this part is also smoothed.
- This mode may not be effective when there is insufficient brightness.

3: [Backlit Softness]

4: [Clear in Backlight]

5: [Relaxing Tone]

6: [Sweet Child's Face]

- When you touch the face, a picture is recorded with the focus and exposure set for the touched location.

7: [Distinct Scenery]

8: [Bright Blue Sky]**9: [Romantic Sunset Glow]****10: [Vivid Sunset Glow]****11: [Glistening Water]**

- The Star filter used in this mode may also cause glistening effects on objects other than a water surface.

12: [Clear Nightscape]**13: [Cool Night Sky]****14: [Warm Glowing Nightscape]****15: [Artistic Nightscape]****16: [Glittering Illuminations]****17: [Handheld Night Shot]**

- After pressing the shutter button, do not move the camera during the exposure series.
- The recorded area is slightly smaller than usual.

18: [Clear Night Portrait]

- Tripod, self-timer recommended.
- When [Clear Night Portrait] is selected, keep the subject still for about 1 second after taking the picture.

19: [Soft Image of a Flower]

- For close-up recording, we recommend you avoid using the flash.

20: [Appetizing Food]

- For close-up recording, we recommend you avoid using the flash.

21: [Cute Dessert]

- For close-up recording, we recommend you avoid using the flash.

22: [Freeze Animal Motion]

- Default [AF Assist Lamp] setting is [OFF].

23: [Clear Sports Shot]**24: [Monochrome]**

Taking Pictures with Different Effects (Creative Control Mode)

Recording mode: 

You can select the effects to be applied from sample pictures and preview these effects on the screen.

1 Set the mode dial to [COL]

2 Press ▲ ▼ to select the picture effect (filters)

 Preview display

- You can also select the picture effects (filters) by touching the example images.

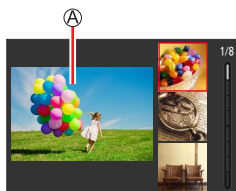

3 Press [MENU/SET]



It is also possible to display the selection screen by touching the Recording mode icon in recording screen.



- Depending on the picture effect, the recording screen may seem as if frames are missed.
- [White Balance] will be fixed to [AWB] and ISO sensitivity to [AUTO].
- The following menu items can be set in the [Creative Control] menu.
 - [Filter Effect]: Allows you to set the picture effect (filter).
 - [Simultaneous Record w/o Filter]: Allows you to set the camera to take a picture with and without a picture effect simultaneously. (→171)

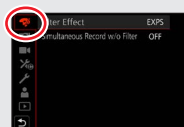

Taking Pictures with Different Effects (Creative Control Mode)

**Displaying the description of each picture effect (Filter)**

Press [DISP] while the picture effect selection screen is displayed

- When it is set to the guide display, explanations for each picture effect are displayed.

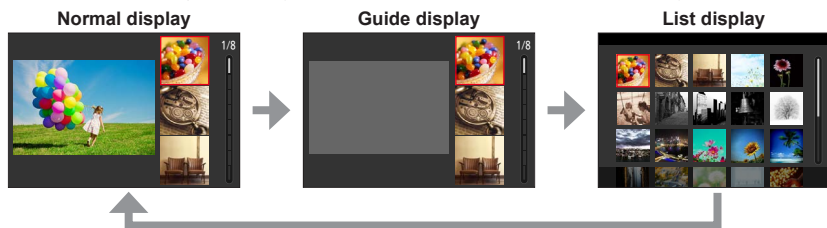
**Types of picture effects****Adjusting the picture effects according to your preferences**

- 1 Press ► to display the setting screen
- 2 Rotate the thumb dial to adjust the setting conditions of the picture effects
 - Press [MENU/SET] to return to the recording screen.

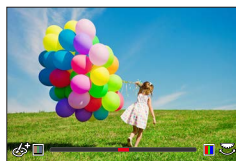

Taking Pictures with Different Effects (Creative Control Mode)

Picture effect	Items that can be set
[Expressive]	Vividness Subdued coloring ↔ Gaudy coloring
[Retro]	Coloring Yellowish coloring ↔ Reddish coloring
[Old Days]	Contrast Low contrast ↔ High contrast
[High Key]	Coloring Pinkish coloring ↔ Light-bluish coloring
[Low Key]	Coloring Reddish coloring ↔ Bluish coloring
[Sepia]	Contrast Low contrast ↔ High contrast
[Monochrome]	Coloring Yellowish coloring ↔ Bluish coloring
[Dynamic Monochrome]	Contrast Low contrast ↔ High contrast
[Rough Monochrome]	Grainy picture effect Weak grainy picture effect ↔ Strong grainy picture effect
[Silky Monochrome]	Degree of defocusing Slight defocusing ↔ Strong defocusing
[Impressive Art]	Vividness Black & white ↔ Gaudy coloring
[High Dynamic]	Vividness Black & white ↔ Gaudy coloring
[Cross Process]	Coloring Greenish coloring / Bluish coloring / Yellowish coloring / Reddish coloring <ul style="list-style-type: none"> • Select the desired color tone by rotating the thumb dial, and press [MENU/SET]. 
[Toy Effect]	Coloring Orangish coloring ↔ Bluish coloring
[Toy Pop]	Range in which peripheral brightness is reduced Small ↔ Large
[Bleach Bypass]	Contrast Low contrast ↔ High contrast
[Miniature Effect]	Vividness Subdued coloring ↔ Gaudy coloring <ul style="list-style-type: none"> • For details about [Miniature Effect] (→74)

Taking Pictures with Different Effects (Creative Control Mode)

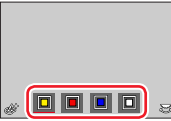
Picture effect	Items that can be set
[Soft Focus]	Degree of defocusing Slight defocusing \longleftrightarrow Strong defocusing
[Fantasy]	Vividness Subdued coloring \longleftrightarrow Gaudy coloring
[Star Filter]	<div style="text-align: center;"> [··x] Length of the light rays Light rays are short \longleftrightarrow Light rays are long [x·*] Number of the light rays Smaller \longleftrightarrow Larger [x·x] Angle of the light rays Rotate to the left \longleftrightarrow Rotate to the right </div>
[One Point Color]	Amount of color retained Leaves a small amount of color \longleftrightarrow Leaves a large amount of color • For details about [One Point Color] (→75)
[Sunshine]	Coloring Yellowish coloring / Reddish coloring / Bluish coloring / Whitish coloring • Rotate the thumb dial to select coloring, and press [MENU/SET]. <div style="text-align: right; margin-top: 10px;">  </div> • For details about [Sunshine] (→75)

■ Setting the type of defocus ([Miniature Effect])

- ① After touching [📷], touch [📷]
- ② Press \blacktriangle \blacktriangledown or \blacktriangleleft \blacktriangleright to move the focusing area frame
 - You can also move the in-focus section by touching the recording screen at the desired area.
 - Touching [📷] allows you to change the recording orientation.
- ③ Rotate the thumb dial to select the size of the focusing area (frame)
 - On the touch screen, spread your 2 fingers to zoom in, and pinch 2 fingers to zoom out.
 - When you press [DISP], the initial setting condition is restored.
- ④ Press [MENU/SET]

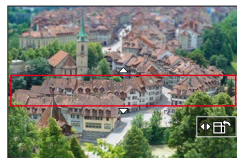

Taking Pictures with Different Effects (Creative Control Mode)

- No audio is recorded for videos.
- When a video is recorded, the finished recording will be approximately 1/10th of the actual recorded time period. (e.g. in case of a 10-minute recording, the resulting video will be approximately 1 minute.) The recordable time displayed on the camera is approx. 10 times of the actual recording time.
- If you stop recording videos too soon, the camera may continue recording for a certain time.

■ Selecting the color to be retained ([One Point Color])

- ① After touching [📷], touch [🎨]
- ② Select the color to be retained with ▲▼◀▶ and press [MENU/SET]
 - You can also select it by touch operations.
 - When you press [DISP], the initial setting condition is restored.



- The selected color may not be retained for some subjects.

■ Setting the position and size of the light source ([Sunshine])

- ① After touching [📷], touch [☀️]
- ② Press ▲▼◀▶ to move the center of the light source to a different position
 - The position of the light source can also be moved by touching the screen.
- ③ Rotate the thumb dial to adjust the size of the light source
 - On the touch screen, spread 2 fingers to zoom in, and pinch 2 fingers to zoom out.
 - When you press [DISP], the initial setting condition is restored.
- ④ Press [MENU/SET]



Tips on positioning the center of the light source

You can move the center of the light source to a point outside the image to obtain a more natural finish.

Taking Pictures with Different Effects (Creative Control Mode)

Setting the brightness (exposure)/blurriness of the background (Defocus control function)

1 Press ▲ to display the setting screen

- The brightness (exposure) operation screen is displayed. Press [Fn1] to operate the defocus control, and then press it again to finish the operation.

2 Rotate the thumb dial to set

- Press [MENU/SET] to return to the recording screen.

When setting the brightness (exposure)

- Press ▲ ▼ to set the Exposure Bracket. (→129)

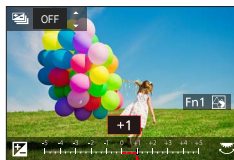
**When setting the background defocusing**

- Pressing [Q/M] (↔) will cancel the setting.

**■ With touch screen operations**

- ① Touch [📷]
- ② Touch the item you want to set
 [📷]: Adjusting the picture effect
 [📷]: Degree of defocusing
 [📷]: Brightness
- ③ Drag the slide bar or exposure meter to set
 - Press [MENU/SET] to return to the recording screen.

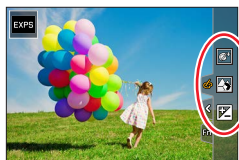

- Defocus control operation is not available in [Miniature Effect] (Creative Control Mode).

Creative Video Mode

Recording mode: 

The operation for changing the aperture value, shutter speed or ISO sensitivity is the same as the operation for setting the mode dial to [P], [A], [S] or [M] (except Program Shift Mode).

1 Set the mode dial to

2 Set the menu

MENU →  [Creative Video] → [Exposure Mode]

Settings: [P] / [A] / [S] / [M]





It is also possible to display the selection screen by touching the recording mode icon in recording screen.





3 Press the video button (or the shutter button) to start recording

① Touch  (Cannot be used during [High Speed Video] recording.)

② Touch icon

	Zoom		Exposure Compensation
F	Aperture value	ISO	ISO sensitivity
SS	Shutter speed		

③ Drag the slide bar to set

	Changes the setting slowly
	Changes the setting quickly

Using touch icons allows silent operation while recording videos.

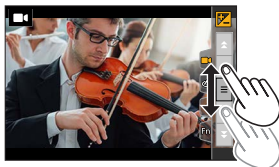

4 Press the video button (or the shutter button) to stop recording

- The ISO sensitivity can be set within the following range.
 - [AUTO], [125] to [6400] ([L.80] to [6400] when [Extended ISO] is set to [ON])

■ Setting the upper limit value of ISO sensitivity when [Sensitivity] is set to [AUTO]

MENU → **■** [Motion Picture] → [ISO Auto Upper Limit (Video)]

Settings: [AUTO] / [200] / [400] / [800] / [1600] / [3200] / [6400]

Recording Slow Motion Videos ([High Speed Video])

Slow motion videos can be recorded by performing recording at a super high speed. When these recordings are played back, the motion is displayed slowly.

- To record pictures, use a UHS Speed Class 3 card.

1 Set the mode dial to **[M]**

2 Set the menu

MENU → **M** [Creative Video] → [High Speed Video] → [ON]

- Recording is done at 120 frames/second with [FHD] in [MP4].

3 Press the video button (or the shutter button) to start recording

4 Press the video button (or the shutter button) to stop recording

- When recording, the recorded area is slightly smaller than usual.
- No sound is recorded.
- Files are split into separate files for recording and playback when their size would otherwise exceed 4 GB. (You can continue to record the video without interruption.)
Recording stops when the continuous recording time exceeds 29 minutes.
(In terms of playback time, you can record up to approximately 120 minutes.)
- The focus and zoom settings are fixed to those specified when recording was started.
- Flickering or horizontal stripes may appear while recording under fluorescent lighting.

Panning or zooming while recording with the camera in a fixed position ([4K Live Cropping])

By cropping your video down from the 4K angle of view to Full High Definition, you can record a video and pan and zoom in/out while leaving the camera in a fixed position.



Pan



Zoom in

- Hold the camera firmly in place while recording.
- A video will be recorded at [FHD/20M/30p] under [MP4].

1 Set the mode dial to [M]

2 Set the menu

[MENU] → **[M]** [Creative Video] → [4K Live Cropping]

Settings: [40SEC] / [20SEC] / [OFF]

3 Select the crop start frame and press [MENU/SET] to set

Ⓐ Crop start frame

- When making settings for the first time, a crop start frame with a resolution of 1920×1080 is displayed. (After setting the crop start and end frames, the start and end frames you set immediately before will be displayed.)
- The camera will remember the frame position and resolution even when it is turned off.

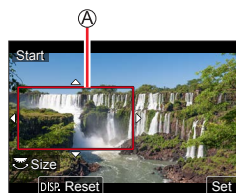

Operation	Touch operation	Description
▲▼◀▶	Touch	Moves the frame
	Spread / Pinch	Increases/reduces the resolution (The range of settings allowed is from 1920×1080 to 3840×2160.)
[DISP]	[Reset]	Returns the position of the frame to the center and its resolution to the default setting
[MENU/SET]	[Set]	Determines the position and resolution of the frame

4 Repeat step 3, and then set the crop end frame

Ⓑ Crop end frame

- The setting of [AF Mode] switches to [👤] (Face Detection). (Eye Detection cannot be used.)

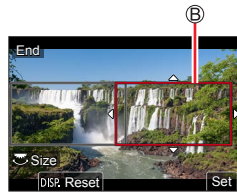

5 Press the video button (or the shutter button) to start recording

Ⓒ Elapsed recording time

Ⓓ Set operating time

- Immediately release the video button (or the shutter button) after pressing it.
- When the set operating time has elapsed, recording automatically ends. To end recording midway, press the video button (or the shutter button) again.

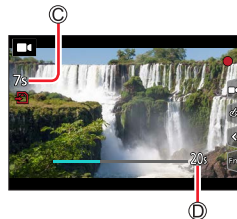

When you want to zoom in/out, set different frames for the cropping start and end frames. For example, to zoom in, set a larger start frame and a smaller one for the end frame.

■ Changing the position and size of a crop frame

Press [Fn3] while the recording screen is displayed, and perform steps **3** and **4**.

■ To cancel [4K Live Cropping] recording

Select [OFF] in step **2**.

- The recorded area is slightly smaller than usual.
- [4K Live Cropping] recording cannot be performed when [High Speed Video] is set.
- Focus is set and fixed in the crop start frame.
- [Continuous AF] is set to [OFF].
- [Metering Mode] will be [☉] (Multi Metering).
- You cannot zoom in/out during [4K Live Cropping] recording.

Registering your own settings and recording

(Custom Mode)

Recording mode: 

Registering your own settings ([Cust.Set Mem.])

Up to 3 sets of camera settings can be registered using [Cust.Set Mem.].

([C1], [C2], [C3])

- Initial setting of the Program Mode is registered as the custom settings initially.

Preparations

- Set the recording mode and menu settings in advance so that the camera can be in the state with the settings to be saved.

MENU →  **[Setup]** → **[Cust.Set Mem.]**
→ **Custom set where you want to register settings**

- The following menu items are not registered as custom settings.

[Custom] menu	[Setup] menu	[Playback] menu
<ul style="list-style-type: none"> • [Menu Guide] • Data registered with [Face Recog.] • The [Profile Setup] setting 	<ul style="list-style-type: none"> • All menus 	<ul style="list-style-type: none"> • [Rotate Disp.] • [Picture Sort]

Registering your own settings and recording (Custom Mode)

Recording using a registered custom set**1 Set the mode dial to [C]**

- The custom set you used last time will be called up.

■ To change a custom set

- ① Set the mode dial to [C]
- ② Press [MENU/SET] to bring up the menu
- ③ Press ▲▼ to select the custom set you want to use, and then [MENU/SET]

- The settings are switched to those settings you selected for the custom set.



It is also possible to display the selection screen by touching the recording mode icon in recording screen.

**■ Changing the registered content**

Even if the menu settings are changed temporarily when the mode dial has been set to [C], the currently registered settings will remain unchanged. To change the currently registered settings, overwrite the registered data using [Cust.Set Mem.] in the [Setup] menu.

Using Autofocus

Recording modes:

1 Press (◀)

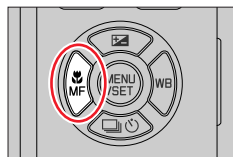

2 Press ◀▶ to select [AF] and then [MENU/SET]

- Focusing starts when the shutter button is pressed halfway (→84)
- Switching [AF Mode] (→85)

3 Press the shutter button halfway

- Ⓐ Focus display
(When focus is achieved: illuminated
When focus is not achieved: flashing)
- Ⓑ AF area
(When focus is achieved: green)

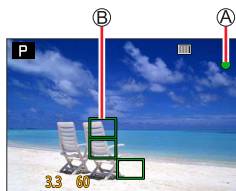

- Two “beep” sounds are heard and Autofocus is activated. Four “beep” sounds when focus is not achieved.
- When you take a picture in a dark location, [] is displayed for the focus display and it may take longer to focus than usual.
- If the camera detects stars in the night sky after displaying [], Starlight AF will be activated. When focus is achieved, the focus indication [] and AF areas in focus are displayed. (Starlight AF cannot perform detection on the edges of the screen.)



Subjects/environments which may make focusing difficult:

- Fast-moving or extremely bright objects, or objects with no color contrast.
- Taking pictures through glass or near objects emitting light.
- In the dark, or with significant camera shake.
- When too close to an object or when both distant and close objects appear together in the same picture.

- When ambient lighting is low making it difficult to focus with Autofocus, set [Monitor Display Speed] or [EVF Display Speed] to [60fps].
- Starlight AF will not function when using the monitor with [Monitor Display Speed] set to [ECO 30fps] or when using the viewfinder with [EVF Display Speed] set to [ECO 30fps].

Set the focusing operation to be performed when the shutter button is pressed halfway (AFS, AFF, AFC)

Recording modes:          

MENU →  **[Rec]** /  **[Motion Picture]** → **[AFS/AFF/AFC]**

Settings	The movement of the subject and the scene (recommended)	Description
[AFS]	Subject is still (Scenery, anniversary photograph, etc.)	"AFS" is an abbreviation of "Autofocus Single". Focus is set automatically when the shutter button is pressed halfway. The focus setting will be fixed as long as it is pressed halfway.
[AFF]	Movement cannot be predicted (Children, pets, etc.)	"AFF" is an abbreviation of "Autofocus Flexible". In this mode, focusing is performed automatically when the shutter button is pressed halfway. If the subject moves during that time, the focus is corrected to match the movement automatically.
[AFC]	Subject is moving (Sport, trains, etc.)	"AFC" is an abbreviation of "Autofocus Continuous". In this mode, while the shutter button is pressed halfway, focusing is constantly performed to match the movement of the subject.



When recording using [AFF], [AFC]

- When the subject is moving, the focusing is performed by predicting the subject position at the time of recording. (Movement prediction)
- Focusing may take time when zooming from one end of the focal length range to the other, or if you suddenly move closer to a subject from a greater distance.
- Press the shutter button halfway again when it is difficult to focus on the subject.
- While the shutter button pressed halfway, shake may be seen on the screen.







- [AFF] or [AFC] operates as [AFS] in the following case:
 - Creative Video Mode
 - When recording with  ([4K Burst(S/S)]) of the 4K Photo function.
 - When ambient lighting is low.
- It is fixed to [AFS] when Panorama Shot Mode is set.
- [AFF] is not available when recording 4K photos. Continuous AF works during recording.
- This setting cannot be used when recording using [Post Focus].





Switching [AF Mode]

Recording modes:         

This allows selecting the focusing method that suits the positions and number of the subjects to be rendered sharply.

MENU →  [Rec] /  [Motion Picture] → [AF Mode]

Settings:  (Face/Eye Detection) /  (Tracking) /  (49-area-focusing) /  etc. (Custom Multi) /  (1-area-focusing) /  (Pinpoint-focusing)
(→86 - 90)

- In Snapshot Mode and Snapshot Plus Mode,  or  can be set.
- The [AF Mode] is fixed to  in the following case:
 - When recording using [4K Live Cropping]
- Autofocus is fixed to  in the following cases:
 - When using the Digital Zoom
 - [Miniature Effect] (Creative Control Mode)
- [AF Mode] cannot be set in the following cases:
 - When recording using [Post Focus]
 - When [Pull Focus] in [Snap Movie] is set to [ON]

Taking head-on pictures of people (Face/Eye Detection)

The camera automatically detects the faces and eyes of subjects. It adjusts the focus on the eye that is closer to the camera and the exposure based on the face (when [Metering Mode] is set to  (Multi Metering)).

- The camera can detect up to 15 faces. The camera detects only the eye of the face focused on.
- When the camera recognizes a face, the AF area and the eye used for focusing are displayed.

 Eye used for focusing

Yellow: When the shutter button is pressed halfway and the subject is focused, the frame turns green.

White: Displayed when more than one face is detected. Other faces that are the same distance away as faces within the yellow AF area will also be in focus.

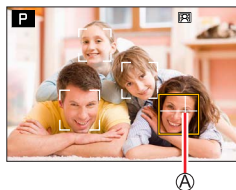



■ Changing the eye to be in focus

Touch the eye to be used for focusing

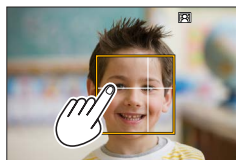
- If you touch  or press [MENU/SET], the eye focus setting will be canceled.



-  (Face/Eye Detection) cannot be set in the following cases:

- [Clear Nightscape], [Cool Night Sky], [Warm Glowing Nightscape], [Artistic Nightscape], [Glittering Illuminations], [Handheld Night Shot], [Appetizing Food], [Cute Dessert] (Scene Mode)
- The eye to be in focus cannot be changed when [4K Live Cropping] is set.
- If conditions prevent the face from being recognized, such as when the movement of the subject is too rapid, the AF Mode setting switches to  (49-area-focusing).

Automatically locking the focus on a moving subject (tracking)

With cursor button operations

Aim the AF tracking area at the subject and press the shutter button halfway

 AF Tracking area

When the subject is recognized, the AF tracking area turns green. When you release the shutter button, the AF tracking area turns yellow and the subject is automatically kept in focus.

- To stop AF Tracking → Press [MENU/SET].
- Focusing range: same as macro recording [] (→96)

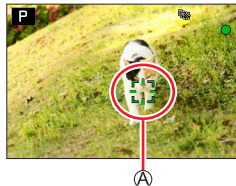





With touch screen operations

Touch the subject

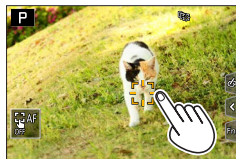
Perform these operations with the touch shutter function deactivated. The AF Tracking area turns yellow while the subject is locked.

- To stop AF Tracking → Touch [].



- If AF Lock fails, a red frame flashes for a while and then turns off.
- When you set [Metering Mode] to [] (Multi Metering), the camera adjusts the exposure using a locked subject. (→172)
- Under certain recording conditions, such as when the subject is small or dark, AF Tracking may not operate correctly. When AF Tracking does not work, focus will be on [] (1-area-focusing).
- This function is not available in the following case:
 - When using [Time Lapse Shot]
- In the following cases, [] performs the operation of [] (1-area-focusing).
 - [Glistening Water], [Glittering Illuminations], [Soft Image of a Flower], [Monochrome] (Scene Mode)
 - [Sepia], [Monochrome], [Dynamic Monochrome], [Rough Monochrome], [Silky Monochrome], [Soft Focus], [Star Filter], [Sunshine] (Creative Control Mode)
 - [Monochrome], [Monochrome HC] ([Photo Style])

Subject not centered in picture  (49-area-focusing)

Focuses on a subject detail in the wide range area (up to 49-area-focusing) on the recording screen.

**Setting the shape of an AF area** , etc. (Custom Multi)

You can set the preferred shape of an AF area by selecting 49 frames in the AF area, based on the subject.





MENU →  [Rec] /  [Motion Picture] → [AF Mode]

1 Select a Custom Multi icon ([]), etc.), and press **▲**

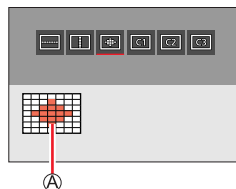
2 Use **◀▶** to select the setting item

(A) Current AF area shape



 ([Horizontal Pattern])	Ideal shape for panning, etc.	
 ([Vertical Pattern])	Ideal shape for recording structures, etc.	
 ([Central Pattern])	Ideal shape for focusing around the center.	
 ([Custom])	You can set a custom registration shape.	

3 Press **▼**

- The AF area setting screen appears.

4 Select the AF area

Ⓑ Selected AF area

When selecting [] / [] / []

① Change the shape of an AF area

Operation	Touch operation	Description
▲▼◀▶	Touch	Moves the position
	Spread / Pinch	Changes the size (in 3 steps)
[DISP]	[Reset]	Resets the AF area back to the center. • If you press the button again, the frame size will be reset to the initial setting.

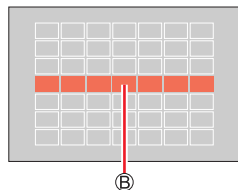

② Press [MENU/SET]

When selecting [C1] / [C2] / [C3]

① Change the shape of an AF area

With cursor button operations

Use ▲▼◀▶ to select an AF area and press [MENU/SET] to set (repeat)

- If you press [MENU/SET] again, the setting will be canceled.
- To cancel all the settings, press [DISP].

With touch screen operations

Touch where you want to set AF areas

- If you touch one of the selected AF areas, the selection of the area will be canceled.

② Press [Fn2]

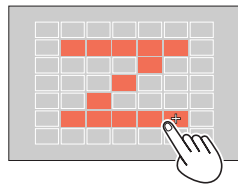



■ Registering the set AF area in [C1], [C2] and [C3] (Custom)

① Press ▲ on the screen of step 2

② Use ▲▼ to select the registration target icon and press [MENU/SET]

- The settings adjusted in [], [] or [] will be restored to the default settings when the camera is turned off.

Determining the position for focus  (1-area-focusing) /  (Pinpoint-focusing)** (1-area-focusing)**



Focuses on the AF area in center of the picture. (Recommended when focus is difficult to achieve)



When the subject is not in the center of the composition in [], you can bring the subject into the AF area, fix the focus and exposure by pressing the shutter button halfway, move the camera to the composition you want with the shutter button pressed halfway, and then take the picture. (Only when [AFS/AFF/AFC] in [Rec] menu is set to [AFS].)

 (Pinpoint-focusing)

Enables more precise focusing on a smaller point than [] (1-area-focusing). When you press the shutter button halfway, an enlarged display of the focus position appears.

- If [] (Pinpoint-focusing) is selected while recording videos or 4K photos, the setting is changed to [] (1-area-focusing).
- [] (Pinpoint-focusing) cannot be set in the following case:
 - When [AFS/AFF/AFC] in [Rec] menu is set to [AFF] or [AFC]

Changing the position and size of the AF area

Recording modes: **A A P A S M M M SCN COL**

When [**AF**], [**AF**], [**AF**], or [**AF**] in Autofocus Mode is selected, you can change the position and size of the AF area. With [**AF**], you can set the lock-on position.

- Perform these operations with the touch shutter function deactivated.
- You can also display the AF area setting screen by touching the recording screen.

MENU → **AF** [**Custom**] → **AF** [**Operation**] → [**Touch Settings**] → [**Touch AF**] → [**AF**]

- You can use the [**Custom**] ([Focus / Release Shutter]) menu to set the display method for the AF area according to your preference. (→182)

- When you set [Metering Mode] to [**AF**] (spot-focusing), the metering target will move along with the AF area.
- The position and size of the AF area cannot be changed in the Digital Zoom range.

■ When selecting [**AF**] / [**AF**] / [**AF**]

MENU → **AF** [**Rec**] / **AF** [**Motion Picture**] → [**AF Mode**]

- ① Select [**AF**], [**AF**] or [**AF**] and press **AF**
 - The AF area setting screen appears.



- ② To change the AF area

Operation	Touch operation	Description
▲▼◀▶	Touch	Moves the position of the AF area.
—	Spread / Pinch	Enlarges/reduces the AF area in small steps.*
	—	Enlarges/reduces the AF area in large steps.*
[DISP]	[Reset]	Resets the AF area back to the center. <ul style="list-style-type: none"> • If you press the button again, the frame size will be reset to the initial setting.

* Not available when [**AF**] is selected.

- ③ Press [MENU/SET]
 - AF area with the same function as [**AF**] is displayed in the touched position, when the [**AF**] is selected. Setting of the AF area is cleared when [MENU/SET] is pressed or [**AF**] is touched.

■ When selecting [AF]

You can set the focus position by selecting an AF area group. The AF area, which is configured with 49 boxes, is divided into groups consisting of 9 boxes each (6 or 4 boxes for the groups located at the edges of the screen).

MENU → **[Rec]** / **[Motion Picture]** → **[AF Mode]**

- ① Select and press ▼
 - The AF area setting screen appears.
- ② Press ▲▼◀▶ to select an AF area group
- ③ Press [MENU/SET]
 - Setting of the AF area is cleared when [MENU/SET] is pressed or is touched.

Examples of group

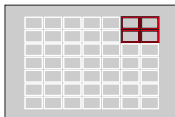
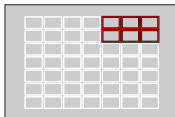
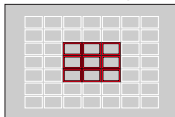

■ When selecting [+]

You can enlarge the screen to perform more precise settings of the focus position.
 • You cannot set the focus position at the edges of the screen.

MENU → [Rec] / [Motion Picture] → [AF Mode]

- ① Select [+] and press ▼
- ② Use ▲▼◀▶ to set the focus position and press [MENU/SET]
 - The enlarged screen will appear for setting the focus position.

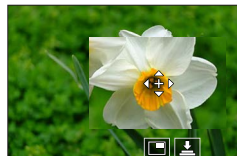

- ③ Move [+] to the focus position

Operation	Touch operation	Description
▲▼◀▶	Touch	Moves [+].
—	Spread / Pinch	Enlarges/reduces the screen in small steps.
	—	Enlarges/reduces the screen in large steps.
—		Switches the enlarged display. (windowed/full screen)
[DISP]	[Reset]	Returns to the screen of step ②.

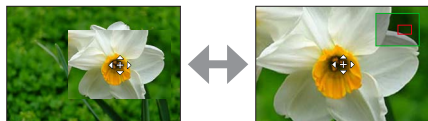

- The image of a part of the screen can be enlarged or reduced approximately 3 to 6 times. The image of the entire screen can be enlarged or reduced approximately 3 to 10 times.
- It is also possible to record a picture by touching [].

- ④ Press [MENU/SET]

Setting the AF area position by touch

Recording modes: **A** **A** **P** **A** **S** **M** **M** **SCN** **COL**

You can move the AF area displayed on the viewfinder by touching the monitor at the desired position.

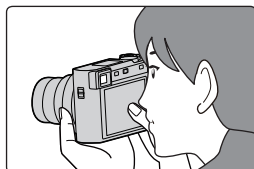

MENU → **☒** **[Custom]** → **⚙️** **[Operation]** → **[Touch Settings]** → **[Touch Pad AF]**

[EXACT]	Moves the AF area in the viewfinder by touching a desired position.	
[OFFSET]	Moves the AF area in the viewfinder to where you drag it.	
[OFF]	—	—

- Press the shutter button halfway to determine the focus position. If you press **[DISP]** before determining the focus position, it returns to the center.
- To cancel the settings for the AF area when the Autofocus Mode is set to **[Face/Eye Detection]**, **[Tracking]**, or **[49-area-focusing]**, press **[MENU/SET]**.

- The Touch Shutter function is disabled when using **[Touch Pad AF]**.
- **[Touch Pad AF]** does not function in the following cases:
 - When recording using **[4K Live Cropping]**
 - When **[Pull Focus]** in **[Snap Movie]** is set to **[ON]**

Optimizing the focus and exposure settings for a touched position

Recording modes: **A** **A** **P** **A** **S** **M** **M** **SCN** **COL**

MENU → **⌘** [Custom] → **⚙️** [Operation] → [Touch Settings] → [Touch AF]
→ [AF+AE]

1 Touch the subject detail you want to optimize the exposure for

- The AF area setting screen appears. (→91)
- The exposure optimization position is displayed in the center of the AF area. The position follows the movement of the AF area.
- [Metering Mode] is set to [☒], which is used exclusively for the [Touch AE].



2 Touch [Set]

- The AF area with the same function as [☒] is displayed on the touched position.
- If you touch [☒] (touch [☒] when [☒] is set), the setting of [AF+AE] is canceled.



When the background has become e.g. too bright using this function, the its brightness can be adjusted by compensating the exposure.

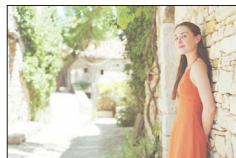

- When recording with Touch Shutter, the focus and exposure settings are optimized for the touched position before recording takes place.
- At the edge of the screen, the metering may be affected by the brightness around the touched location.
- The [AF+AE] does not function in the following cases:
 - When using the Digital Zoom
 - When recording using [4K Live Cropping]

Taking close-up pictures

Recording modes: **A** **A** **P** **A** **S** **M** **M** **SCN** **COL**

This mode allows you to take close-up pictures of a subject, e.g. when taking pictures of flowers.

1 Press **[MF]** (◀)

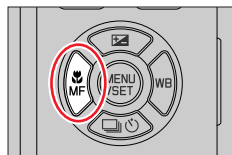

2 Press ◀▶ to select the item and then **[MENU/SET]**

[AF] ([AF Macro])	You can take pictures of a subject as close as 3 cm (1 3/16") from the lens by setting the shortest focal length with the zoom lever.
[M] ([Macro Zoom])	Use this setting to get close to the subject and then further enlarge when taking the picture. You can take a picture with the Digital Zoom up to 3x while maintaining the distance to the subject for the extreme Wide position (3 cm (1 3/16")). <ul style="list-style-type: none"> • Note that enlarging will decrease picture quality. • The zoom range will be displayed in blue (digital zoom range).

- When recording a subject close to the camera, we recommend taking a picture without using the flash.
- A picture may be out of focus when the subject is out of the focusing range, even if the focus display is lit.
- When a nearby subject is to be recorded
 - Using a tripod and [Self Timer] (→127) is recommended.
 - The effective focusing range (depth of field) is significantly shallower. Therefore, if the distance between the camera and the subject is changed after focusing on the subject, it may become difficult to focus on it again.
 - Resolution may be slightly reduced around the edges of the picture. This is not a malfunction.
- [Macro Zoom] cannot be set in the following cases:
 - [Handheld Night Shot] (Scene Mode)
 - Panorama Shot Mode
 - When recording with [High Speed Video]
 - [Impressive Art], [Toy Effect], [Toy Pop], [Miniature Effect] (Creative Control Mode)
 - When [HDR] is set to [ON]
 - When [Multi Exp.] is set
 - When [Quality] is set to [RAW] or [RAW]

Taking pictures with Manual Focusing

Recording modes:

Manual focusing is convenient e.g. when you want to take a series of pictures with the same focus setting or when the autofocus system does not find an appropriate setting.

1 Press (◀)

2 Press ◀▶ to select [MF] and then [MENU/SET]

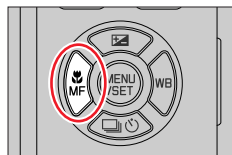

3 Turn the control ring to focus

Turning the control ring to the right:

Focuses on a nearer subject

Turning the control ring to the left:

Focuses on a more distant subject

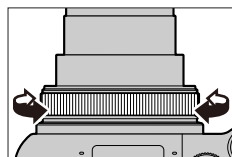

Ⓐ MF Assist (Enlarged screen)

Ⓑ MF Guide (→191)

Ⓒ Peaking

- Color outlines are added to the parts of the image that are in focus. (Peaking) (→188)
- The screen changes to the assist screen and an enlarged display appears. (MF Assist)
You can move the enlarged part by dragging it across the screen.
- You can also enlarge the display by spreading or touching the screen twice.

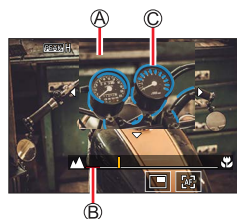

Taking pictures with Manual Focusing

Operation	Touch operation	Description
▲▼◀▶	Drag	Moves the enlarged area.
—	Spread / Pinch	Enlarges/reduces the displayed section in small steps.
	—	Enlarges/reduces the displayed section in large steps.
—	*1	Switches the enlarged display. (windowed/full screen)*2 
[DISP]	[Reset]	Resets the area to be enlarged back to the center.

*1 Cannot be set when using SnapShot Mode.

*2 The image of a part of the screen can be enlarged or reduced approximately 3 to 6 times.
The image of the entire screen can be enlarged or reduced approximately 3 to 10 times.

4 Press the shutter button halfway

- The recording screen will be displayed.
- The same operation can be performed by pressing [MENU/SET].

- When [Focus Switching for Vert / Hor] in the [Custom] ([Focus / Release Shutter]) menu is set, you can set a position of the enlarged area of MF Assist for each direction of the camera.



Quickly adjusting the focus setting using Autofocus

In Manual Focusing, the focus can be set on the subject through Autofocus.

1 Touch

- Autofocus is activated at the center of the frame.
- Autofocus also works with the following operations.
 - Pressing the [AE|AF LOCK] button to which [AF-ON] is assigned (→99)
 - Pressing the function button to which [AF-ON] is assigned (→46)
 - Dragging and releasing your finger at the position you want to focus on
- This function cannot be used when [4K Live Cropping] is set.

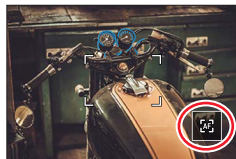

Taking pictures by locking the focus and/or exposure settings

Recording modes: **A A^S P A S M M M SCN COL**

You can use the AF/AE Lock function to fix the focus and exposure settings in advance and change the composition of the picture when recording. This function is convenient when you want to focus on the edge of the screen or when your subject is back-lit.

- 1 Point the camera at the subject**
- 2 Lock the focus and/or exposure by pressing and holding [AE|AF LOCK]**
 - When you release [AE|AF LOCK], the focus and/or exposure lock is canceled.
- 3 While you press and hold [AE|AF LOCK], move the camera to compose the picture you want to take and fully press the shutter button**

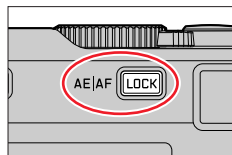

■ Setting the function of [AF/AE LOCK]

MENU → **X** [Custom] → **FOCUS** [Focus / Release Shutter] → **[AF/AE Lock]**

[AE LOCK]	Locks exposure only. • [AEL] is displayed when the correct exposure is achieved.
[AF LOCK]	Locks focus only. • [AFL] is displayed when the subject comes into focus.
[AF/AE LOCK]	Locks focus and exposure. • [AFL] and [AEL] are displayed when the subject is in focus and the correct exposure is achieved.
[AF-ON]	Autofocus is activated.

- AE Lock is disabled in Manual Exposure Mode.
- AF Lock is disabled during Manual Focusing.
- Program Shift can be set even when AE is locked.

Taking pictures with Exposure Compensation

Recording modes: **A** **A** **P** **A** **S** **M** **M** **SCN** **COL**

Use this function when you wish to modify the exposure settings the camera delivers, e.g. when your main subject would otherwise be rendered brighter/darker than you want.

1 Press [Fn] (▲)

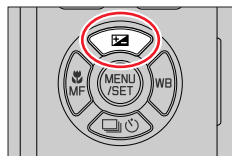

2 Rotate the thumb dial to compensate the exposure

- Ⓐ Exposure Bracket
- Ⓑ Exposure Compensation

• Press ▲▼ to set the Exposure Bracket. (→129)

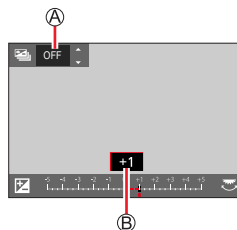

Under-exposed



Adjust the exposure to the [+] direction

Optimum exposure



Adjust the exposure to the [-] direction

Over-exposed



3 Press [MENU/SET] to set

• You can also press the shutter button halfway to set.

- In Manual Exposure Mode, you can correct the exposure only when the ISO sensitivity is set to [AUTO]. (You can select Exposure Compensation when the Quick menu is displayed by pressing [Q/M] ⇨.)
- You can set the exposure compensation value in the range between -5 EV and +5 EV. Settings can be made within a range of -3 EV to +3 EV while recording videos, recording 4K photos, or recording in [Post Focus].
- Depending on the brightness, this may not be possible in some cases.
- When the Exposure Compensation value is out of the -3 EV to +3 EV range, the brightness of the recording screen will no longer change. It is recommended to record by checking the actual brightness of the recorded image in the Auto Review or playback screen.
- The set Exposure Compensation value is stored even if the camera is turned off. (When [Exposure Comp. Reset] is set to [OFF])

Setting the ISO Sensitivity

Recording modes: **A** **A** **P** **A** **S** **M** **M** **M** **SCN** **COL**

Set ISO sensitivity (sensitivity to lighting).

MENU →  **[Rec]** → **[Sensitivity]**

1 Select the ISO sensitivity by rotating the thumb dial

 ISO sensitivity

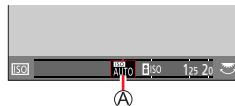

AUTO	ISO sensitivity is automatically set in a range up to 3200 (with the flash on: 4000)* ¹ depending on the brightness of a subject.
 ISO (Intelligent ISO)	ISO sensitivity is automatically set in a range up to 3200 (with the flash on: 4000)* ¹ depending on the movement and brightness of a subject. <ul style="list-style-type: none"> The shutter speed is not fixed when the shutter button is pressed halfway. It is continuously changed to match the movement of the subject until the shutter button is pressed fully.
[L.80] * ² / [L.100] * ² / from [125] to [12500] / [H.25000] * ²	ISO sensitivity is fixed at the selected setting.

*¹ When [ISO Auto Upper Limit (Photo)] is set to [AUTO].

*² Only when [Extended ISO] is [ON].

2 Press **[MENU/SET]** to set

- You can also press the shutter button halfway to set.

Setting the ISO Sensitivity



Setting guide

ISO sensitivity	[125]	↔	[12500]
Location (recommended)	Brighter (outdoors)		Darker
Shutter speed	Slower		Faster
Interference	Lower		Higher
Subject blur	Higher		Lower

- For details on the available flash range used when the ISO sensitivity is set to [AUTO], refer to (→146).
- [ISO] cannot be selected in the following cases:
 - Shutter-Priority Mode
 - Manual Exposure Mode
- When [Multi Exp.] is set, the maximum setting is [3200].
- ISO sensitivity is set to [AUTO] (for videos) while a video is being recorded. You can use the following ISO sensitivity settings when recording in Creative Video Mode ([Motion Picture] menu → [Sensitivity]), when recording 4K photos, or when recording using [Post Focus].
 - [AUTO], [125] to [6400] ([L.80] to [6400] when [Extended ISO] is set to [ON])

Setting the White Balance

Recording modes: **A** **A** **P** **A** **S** **M** **M** **SCN** **COL**

In digital photography, white balance ensures neutral, i.e. natural color reproduction in any light. White balance is based on the camera being preset to reproduce a particular color as white.

You can choose between automatic white balance, various presets, one custom setting based on specific measurements, and a direct setting of the color temperature.

1 Press [WB] (▶)

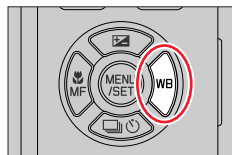

2 Rotate the thumb dial to set the White Balance

[AWB]/ [AWBc]	<p>Automatic setting in accordance with the light source.</p> <ul style="list-style-type: none"> Under a light source (such as an incandescent light) that produces reddish pictures: <ul style="list-style-type: none"> [AWB] gives higher priority to what is seen by the eye and retains the reddish hue. [AWBc] gives higher priority to the original colors of the subject and reduces the reddish hue. <p>When the picture is taken under bright ambient light, the setting sometimes delivers similar colors as those of the [AWB] setting.</p> <ul style="list-style-type: none"> Adjust the colors of the pictures to similar colors when [AWB] or [AWBc] is set under a light source that does not produce reddish pictures.
[☀]	For taking pictures outdoors under a clear sky.
[☁]	For taking pictures outdoors under a cloudy sky.
[🏠]	For taking pictures outdoors in the shade.
[☀]	For taking pictures outdoors under incandescent lights.

Setting the White Balance

[WB]*	For taking pictures with flash as the main/dominant light source.
[M]/[E]/ [E]/[M]	<p>The manually metered and set value is used.</p> <p>① Press ▲</p> <p>② Point the camera at a white object such as a piece of paper, ensuring that it is inside the frame at the center of the screen, and press the shutter button</p> <ul style="list-style-type: none"> • This will set the White Balance and return you to the recording screen. • It may not be possible to set the correct White Balance if subjects are too bright or too dark.
[K]	<p>For using a preset color temperature setting.</p> <p>① Press ▲</p> <p>② Use ▲▼ to select the color temperature value and press [MENU/SET]</p> <ul style="list-style-type: none"> • You can set the color temperature from [2500K] to [10000K].



* The [AWB] setting is applied while recording videos, recording 4K photos, or recording in [Post Focus].

3 Press [MENU/SET] to set

- You can also press the shutter button halfway to set.



Under fluorescent lighting, LED lighting fixtures, etc., the optimal White Balance will vary depending on the lighting type, so use [AWB], [AWBc], [M], [E], [E] or [M].

- The White Balance may not operate correctly if you take pictures using a flash and the subject is situated beyond the effective flash range.
- In the Scene Modes, settings suitable for each scene are made.
- In the Scene Modes, changing the scene or recording mode will return White Balance settings (including the White Balance fine adjustment setting) back to [AWB].

■ Auto White Balance Operational Range

 : operational range

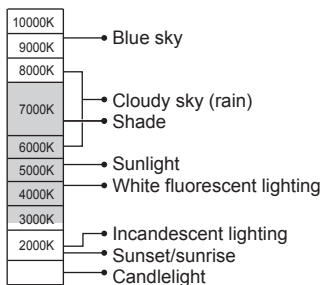

K=Color temperature in degrees Kelvin

Setting the White Balance

Performing White Balance fine adjustments

White Balance settings can be individually fine-tuned if colors still do not appear as anticipated.

1 In step 2 of “Setting the White Balance” (→103), select the White Balance and press ▼

2 Use ▲ ▼ ◀ ▶ to perform White Balance fine adjustments

- ◀: A (amber: orangish colors) ▶: B (blue: bluish colors)
- ▲: G (green: greenish colors) ▼: M (magenta: reddish colors)

- You can also make fine adjustments by touching the White Balance graph at the desired position.
- Pressing [DISP] resets the position back to the center.

3 Press [MENU/SET] to finalize the setting

- Press the shutter button halfway to return to the recording screen.

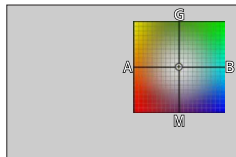

- When you perform fine adjustments of the White Balance toward the A (amber) or B (blue) side, the color of the White Balance icon displayed on the screen will change to the fine-tuned color.
- When you perform fine adjustments of the White Balance toward the G (green) or M (magenta) side, [+] (green) or [-] (magenta) will be displayed in the White Balance icon on the screen.

Setting the White Balance

Bracket recording using White Balance

Bracket settings are performed based on the fine adjustment values for White Balance, and three photos with different coloring are automatically recorded when the shutter button is pressed once.

1 Perform fine adjustments of the White Balance in step 2 of “Performing White Balance fine adjustments” (→106) and rotate the thumb dial to perform the Bracket setting

- You can also set the bracket by touching [◀] / [▶] / [◀] / [▶] / [◀] / [▶].

2 Press [MENU/SET] to finalize the setting

- Press the shutter button halfway to return to the recording screen.

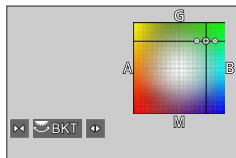

- You can also set the White Balance Bracket in [Bracket] in the [Rec] menu. (→128)
- This function is not available in the following cases:
 - Panorama Shot Mode
 - [Glistening Water], [Glittering Illuminations], [Handheld Night Shot], [Soft Image of a Flower] (Scene Mode)
 - When using [Burst]
 - When recording 4K photos
 - When recording using [Post Focus]
 - When taking pictures while a video is being recorded
 - When [Quality] is set to [RAW:III], [RAW:II] or [RAW]
 - When [Multi Exp.] is set
 - When using [Time Lapse Shot]
 - When [Auto Shooting] of [Stop Motion Animation] is set to [ON]

Recording with the 4K Photo function and selecting pictures to save

Recording with the 4K Photo function

Recording modes:

You can take a series of photos with a resolution of approximately 8 million pixels with a frame rate of 30 fps. You can select and save a frame from the resulting photo series file.

- Use a UHS Speed Class 3 card.

1 Press [4K]

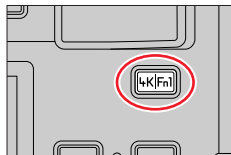

- The same operation can be performed by pressing [Fn] (▼), using ◀▶ to select a 4K photo icon, and pressing ▲.

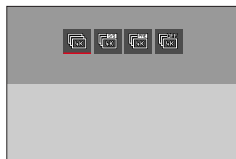

2 Press ◀▶ to select the recording method and then [MENU/SET]

- The recording method can also be set using [4K PHOTO] in the [Rec] menu.



 [4K Burst]	For capturing the best shot of a fast-moving subject (e.g., sports, aeroplanes, trains) Audio recording: None
 [4K Burst(S/S)] "S/S" is an abbreviation of "Start/Stop".	For capturing unpredictable photo opportunities (e.g., plants, animals, children) Audio recording: Available*
 [4K Pre-Burst]	For recording as needed whenever a photo opportunity arises (e.g. the moment when a ball is thrown) Audio recording: None

* Audio is not played back when you perform playback with the camera.

Recording with the 4K Photo function and selecting pictures to save

3 Recording with the 4K Photo function



[4K Burst]

- ① Press the shutter button halfway
- ② Press and hold the shutter button fully for as long as you want to perform recording
 - Recording will start approximately 0.5 seconds after you press the shutter button fully. Therefore, press the button fully slightly in advance of the intended movement.

- Ⓐ Press and hold
- Ⓑ Recording is performed

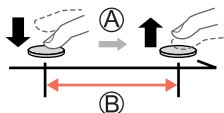

[4K Burst(S/S)]

"S/S" is an abbreviation of "Start/Stop".

- ① Press the shutter button fully
 - Recording will start.
- ② Press the shutter button fully again
 - Recording will stop.

- Ⓒ Start (First)
- Ⓓ Stop (Second)
- Ⓔ Recording is performed

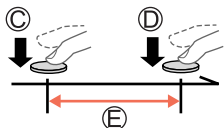

When you press [Fn1] while recording, you can add a marker. (Up to 40 markers for each recording.) When selecting and saving pictures from a 4K photo series file, you can skip to the positions where you added markers.

Recording with the 4K Photo function and selecting pictures to save

**[4K Pre-Burst]**① **Press the shutter button fully**

- The camera focuses continuously when using Autofocus. Except when in Manual Exposure Mode, it also adjusts the exposure continuously.
- Images may not be displayed as smoothly as when recording with the normal recording screen.

Ⓕ Approximately 1 second

Ⓖ Recording is performed

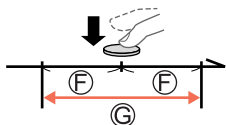

In situations where you want to lock focus and exposure, such as when the subject is not in the center, use [AF/AE LOCK]. (→99)

- Photo series are saved as a single 4K file in the MP4 format.
- When [Auto Review] is enabled, the picture selection screen will be displayed automatically. To continue recording, press the shutter button halfway to display the recording screen.
- For information on how to select and save pictures from 4K photo series files, refer to (→111).

■ To cancel the 4K Photo functions

In step 2, select [].

- The operation can be canceled by pressing the [] button (▼) and then selecting [] ([Single]) or [] ([Off]).



Battery drainage and camera temperature

- If the surrounding temperature is high or 4K photos are recorded continuously, [] may be displayed and recording may be stopped halfway through. Wait until the camera cools down.
- **When [] ([4K Pre-Burst]) is set, the battery drains faster and the camera temperature rises. (to protect itself, the camera may switch to [] ([4K Burst]))**
Select [] ([4K Pre-Burst]) only when recording.

Recording with the 4K Photo function and selecting pictures to save

Selecting pictures from 4K photo series files and saving**1 Select a picture with the [▲] [4K] on the playback screen, and press ▲**

- The same operation can be performed by touching [▲] [4K].
- In the case of recording with [4K] ([4K Pre-Burst]), proceed to step 3.

**2 Drag the slide bar to perform rough picture selection**

- For information on how to operate the slide view screen, refer to (→112).
- If you touch [m] (or press [Fn2]), you can choose a scene in the 4K photo series playback screen. (→113)

Slide view screen

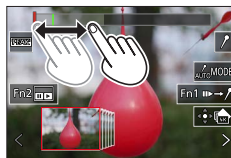
**3 Drag to select the frame you want to save as a picture**

- The same operation can be performed using ◀▶.

**4 Touch [4K] to save the picture**

- The selected picture will be saved as a new one in the JPEG format separate from the 4K photo series file.
- The picture will be saved with recording information (Exif information), including its shutter speed, aperture and ISO sensitivity information.













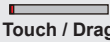

If you use [4K PHOTO Bulk Saving] in the [Playback] menu, you can bulk save 5 seconds' worth of 4K recording. (→214)

Recording with the 4K Photo function and selecting pictures to save

<Slide view screen>

Ⓐ Position of the displayed frame



Operation	Touch operation	Description
—	 Touch / Drag	Selects the frames to be displayed • Frames preceding and following the selected one will be displayed in slide view.
	 Drag	Selects the frame • To switch the slide view, select the frame at either end and touch [<] or [>].
Press and hold 	 Touch and hold	Continuously scrolls the frames or scrolls frame-by-frame backward or forward.
	Spread / Pinch	Enlarges/reduces the displayed area
	Drag	Moves the enlarged area (during enlarged display)
—	 AUTO MODE	Switches a marker to be displayed (→115)
[Fn1]		Switches to marker operation (→114)
[Fn2]		Displays the 4K photo series playback screen
—		Adds/deletes a marker
—		In-focus subject details are highlighted with colored edges. ([Peaking]) • Switches in order of [PEAK OFF] → [PEAK L] ([LOW]) → [PEAK H] ([HIGH]).
[MENU/SET]		Saves the picture

Recording with the 4K Photo function and selecting pictures to save

<4K photo series playback screen>



During pause

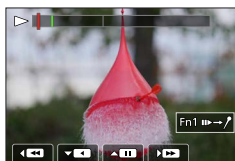

During continuous playback

Operation	Touch operation	Description
—	Touch / Drag	Selects the frames to be displayed (while paused)
▲		Continuous playback / Pause (during continuous playback)
▼		Continuous rewind / Pause (during continuous rewind)
		Fast forward playback / Single-frame forward (while paused)
		Fast rewind playback / Single-frame rewind (while paused)
	Spread / Pinch	Enlarges/reduces the displayed area (while paused)
▲▼◀▶	Drag	Moves the enlarged area (during enlarged display)
—		Switches a marker to be displayed (→115)
[Fn1]		Switches to marker operation (→114)
[Fn2]		Displays the slide view screen (while paused)
—		Adds/deletes a marker
—		In-focus subject details are highlighted with colored edges. ([Peaking]) • Switches in order of [PEAK OFF] → [PEAK L] ([LOW]) → [PEAK H] ([HIGH]).
[MENU/SET]		Saves the picture (while paused)

- You can also zoom in by quickly touching the touch screen twice. (If the display was enlarged, it returns to the same magnification ratio.)

Recording with the 4K Photo function and selecting pictures to save

■ Selecting and saving pictures on the TV screen

- Set [HDMI Mode (Play)] to [AUTO] or [4K/30p]. When connecting to a TV that does not support 4K video, select [AUTO].
- If you connect the camera to a TV and display 4K photo series files on the TV, they will be displayed only on the 4K photo series playback screen.
- Even if you insert the SD card to a 4K-compatible TV with an SD card slot, you cannot play back 4K photo series files recorded with [Aspect Ratio] set to an option other than [16:9]. (As of June 2018)
- Depending on the TV to be connected, 4K photo series files may not be played back correctly.

Marker

When selecting and saving pictures from a 4K photo series file, you can select pictures easily by skipping between marked positions.

■ Skips to the marked positions

When [**▶**→**↗**] is touched on the slide view screen or 4K photo series playback screen, the marker operation screen appears and you can skip to the marked positions. Touch [**↗**→**▶**] to return to the original operation.

Operation	Touch operation	Description
◀ / ▶	⏪ / ⏩	Moves to the previous/next marker.

Two types of markers are available.

White marker: This is manually set during recording or playback.

Green marker: This is automatically set by the camera during recording. (Auto Marking function)

Ⓐ Manually set marker (white)

Ⓑ Marker set using the Auto Marking function (green)

Marker operation screen

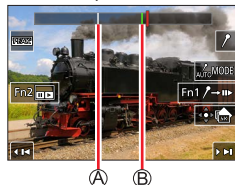

Recording with the 4K Photo function and selecting pictures to save

**Auto Marking function**

The camera automatically sets markers on scenes in which a face or the movement of a subject is detected.

(Example: In a scene when a vehicle passes by, a balloon bursts, or a person turns around)

- Up to 10 markers are displayed for each file.
- In the following cases, markers may not be set by the Auto Marking function depending on the recording conditions and the status of subjects.
 - The camera is moving because of panning or camera shake
 - The movement of a subject is slow/small, or the subject is small
 - A face is not facing the camera

■ Switching a marker to be displayed

Touch  on the slide view screen, 4K photo series playback screen, or marker operation screen.

[Auto]	Displays a marker on a scene in which a face or the movement of a subject is detected.
[Face Priority]	Displays a marker with preference given to a scene in which a face is detected.
[Motion Priority]	Displays a marker with preference given to a scene in which the movement of a subject is detected.
[Off]	Displays manually set markers only.

- You cannot delete markers set by the Auto Marking function.
- The markers set by the Auto Marking function may not be displayed correctly if you split the 4K photo series file on a device other than this camera and then play it back on the camera.
- In the following cases, markers set by the Auto Marking function are not displayed.
 - 4K photo series files recorded with [4K Pre-Burst]

Recording with the 4K Photo function and selecting pictures to save

Notes on the 4K Photo function

■ To change the aspect ratio

Selecting [Aspect Ratio] in the [Rec] menu allows you to change the aspect ratio for 4K photos.

■ To record the subject with reduced blur

You can reduce the blur of the subject by setting a faster shutter speed.

- ① Set the mode dial to [S]
- ② Set the shutter speed by rotating the thumb dial
 - Approximate shutter speed for outdoor recording in fine weather conditions: 1/1000 seconds or faster.
 - If you increase the shutter speed, the ISO sensitivity becomes higher, which may increase the noise in the image.

■ Preventing camera shake when you are recording pictures

When you perform [Light Composition] or [Sequence Composition], we recommend using a tripod and taking pictures remotely by connecting the camera to a smartphone to prevent camera shake. (→236)

■ Shutter sound for 4K photo recording

- When using [] ([4K Burst]) or [] ([4K Pre-Burst]), you can change the electronic shutter sound settings in [Shutter Vol.] and [Shutter Tone]. (→198)
- When recording with [] ([4K Burst(S/S)]), you can set the start/stop tone volume in [Beep Volume].
- You can perform high speed serial exposure recording quietly using the 4K Photo function in combination with [Silent Mode]. (→176)

■ Scenes not suitable for the 4K Photo function

Recording indoors

When recording under fluorescent lighting or LED lighting fixtures, etc., the colors and brightness may change or horizontal striping may appear on the screen. The striping may be reduced by setting a slower shutter speed. (→180)

Fast-moving subjects

Subjects moving fast may appear distorted when recorded.

Recording with the 4K Photo function and selecting pictures to save

■ The camera's setup for the 4K Photo function

- The camera's setup is automatically optimized for 4K photo recording.
- The following settings are fixed.

[Picture Size]	[4K] (8M)	
	[4:3]: 3328×2496 [16:9]: 3840×2160	[3:2]: 3504×2336 [1:1]: 2880×2880
[Quality]		
[Shutter Type]	[ESHTR]	
[Rec Quality]*	[4K/100M/30p]	
[Continuous AF]*	[ON]	

*Settings in the [Motion Picture] menu are not applied to 4K photo series files recorded with the 4K Photo function.

- The following limitations apply to the recording functions indicated below.

	([4K Burst])/ ([4K Burst(S/S)])	([4K Pre-Burst])
Program Shift	Disabled	
Exposure compensation	-3 EV to +3 EV	
Shutter speed	1/30 to 1/16000	
[Min. Shtr Speed]	1/1000 to 1/30	
[AFS/AFF/AFC] ([AFF])	Disabled	
[AF Mode] ([])	Disabled	
[MF Assist]	○	Disabled
White Balance ()	Disabled	
ISO sensitivity	[AUTO], [125] to [6400] ([L.80] to [6400] when [Extended ISO] is set to [ON])	
Flash	Disabled	
Bracket recording	Disabled	

- The following menu items are disabled:

[Snapshot Mode]	[iHandheld Night Shot], [iHDR]
[Creative Control]	[Simultaneous Record w/o Filter]
[Rec]	[Picture Size], [Quality], [Color Space], [Flash], [Long Shtr NR], [Shutter Type], [Bracket], [HDR]
[Custom]	[Rec Area], [Face Recog.], [Profile Setup]
[Setup]	[Economy] (Only ([4K Pre-Burst])), [Monitor Display Speed], [EVF Display Speed]

Recording with the 4K Photo function and selecting pictures to save

- Recording stops when the continuous recording time exceeds 15 minutes.
When using an SDHC memory card, files are split into several files for recording and playback if the file size would otherwise exceed 4 GB. (You can continue to record pictures without interruption.)
If using an SDXC memory card, you can record pictures in a single file even if its size is greater than 4 GB.
- When recording, the recorded area is slightly smaller than usual.
- The following changes occur when recording 4K photos:
 - [Destination] in [Travel Date] cannot be recorded.
 - [Simultaneous Record w/o Filter] in [Filter Settings] is not available.
 - It is not possible to use the HDMI output.
- When recording using the [4K] (4K Pre-Burst) function, Step Zoom does not operate.
- Scene Detection in Snapshot Mode works the same way as when recording videos.
- The 4K Photo function is disabled when using the following settings:
 - [Clear in Backlight], [Glistening Water], [Artistic Nightscape], [Glittering Illuminations], [Handheld Night Shot], [Clear Night Portrait], [Soft Image of a Flower] (Scene Mode)
 - [Rough Monochrome], [Silky Monochrome], [Miniature Effect], [Soft Focus], [Star Filter], [Sunshine] (Creative Control Mode)
 - During video recording
 - When [Multi Exp.] is set
 - When using [Time Lapse Shot]
 - When using [Stop Motion Animation]

Selecting the focusing plane after recording

([Post Focus]/[Focus Stacking])

Recording modes: **A A P A S M** **M** **SCN COL**

You can record 4K photo series files while changing the focus point and then select one of them after recording. This function is best for non-moving subjects.

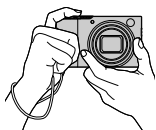

4K serial photo recording with automatic focus shift



Touch the desired focus point



Finished picture has the desired focus point

- To record pictures, use a UHS Speed Class 3 card.
- We recommend using a tripod to perform [Focus Stacking].

Recording using [Post Focus]

1 Press [PF]

2 Press ◀▶ to select [ON] and then [MENU/SET]

A [Post Focus] icon

- You can also set it to [ON] by pressing [**☰**] (**▼**), using ◀▶ to select a [Post Focus] icon (**☰**).

3 Determine the composition and press the shutter button halfway

- Autofocus activates and automatically detects the focus point on the screen.
- If there is no focus point on the screen, the Focus indicator (**●**) flashes and you cannot record.



From halfway pressing the shutter button to completion of recording

- Do not change the distance to subject or the composition.

Selecting the focusing plane after recording ([Post Focus]/[Focus Stacking])

4 Press the shutter button fully to start recording**B** Recording progress bar

- The focus point changes automatically while recording. When the recording progress bar disappears, recording automatically ends.
- The data will be saved as a single file in the MP4 format.
- If [Auto Review] is set, a screen will automatically appear that lets you select the focus point. (→121)

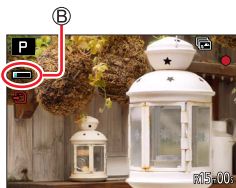
**■ Canceling [Post Focus]**

Select [OFF] in step **2**.

- The operation can be canceled by pressing [] (▼) and then selecting [] ([Single]) or [] ([Off]).

**About camera temperature**

If the surrounding temperature is high or [Post Focus] recording is performed continuously, [] may be displayed and recording may be stopped halfway through. Wait until the camera cools down.

Selecting the focusing plane after recording ([Post Focus]/[Focus Stacking])

Selecting a focus point and saving the picture ([Post Focus])

1 On the playback screen, select the image with the [▲▼◀▶] icon and press ▲

- The same operation can be performed by touching [▲▼◀▶].



2 Touch the subject detail to be focused

- If there are no pictures with the focus on the selected point, a red frame will be displayed, and pictures cannot be saved.
- The edge of the screen cannot be selected.



Operation	Touch operation	Description
▲▼◀▶ ☀ ☺	Touch	Selects a focus point • No selection can be made while the display is enlarged.
🔍	🔍	Enlarges the display
	↶	Reduces the display (when in enlarged display)
[Fn1]	📷	Switches to [Focus Stacking] operation (→122)
[Fn2]	PEAK	In-focus subject parts are highlighted with colored edges. ([Peaking]) • Switches in order of [PEAK OFF] → [PEAK L] ([LOW]) → [PEAK H] ([HIGH]).
[MENU/SET]	🏠	Saves the picture

- You can make fine adjustments to the focus by dragging the slide bar during enlarged display. (The same operation can be performed using ◀▶.)

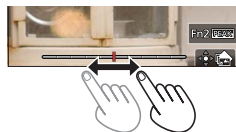

3 Touch [🏠] to save the picture

- The selected picture will be saved as a new separate file in the JPEG format.

Selecting the focusing plane after recording ([Post Focus]/[Focus Stacking])

Determining subject parts to be in focus by combining several shots and creating a single picture ([Focus Stacking])

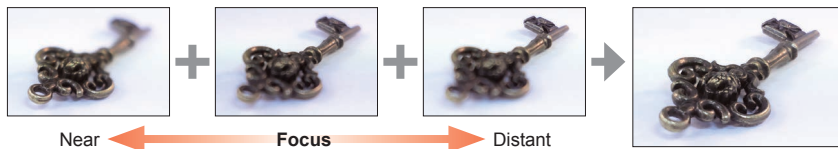

1 Touch on screen in step 2 of "Selecting a focus point and saving the picture ([Post Focus])" (→121)

- The same operation can be performed by pressing [Fn1].

2 Choose a stacking method and touch it

[Auto Merging]	Automatically selects photos suitable for stacking and combines them into one picture. <ul style="list-style-type: none"> • Focus point selection is based on objects closer to the camera. • Performs the focus stacking and saves the picture.
[Range Merging]	Combines the pictures with the selected focus positions into one picture.

(When selecting [Range Merging])

3 Touch the focus point

- Select positions at two or more points.
- Focus points between the selected two positions will be selected.
- Positions that cannot be selected, or that would produce an unnatural result will be grayed out.

- Touch a position again to deselect it.
- If you drag the screen you can then continue to select positions.

Operation	Touch operation	Description
▲▼◀▶	Touch	Selects the position
[Fn2]	[Set/Cancel]	Sets/clears the position
[DISP]	[All]	Selects all positions (Before selecting position)
	[Reset]	Deselects All (After selecting position)
[MENU/SET]		Combines and saves the picture

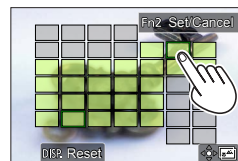
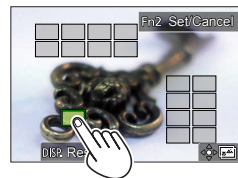

Selecting the focusing plane after recording ([Post Focus]/[Focus Stacking])

4 Touch to combine and save the picture

- The picture will be saved in JPEG format with recording information (Exif information) from the nearest position's picture, including its shutter speed, aperture and ISO sensitivity information.

Notes on the [Post Focus]/[Focus Stacking]

■ The camera's setup for recording in [Post Focus]

- Since recording is performed in the same resolution as 4K photos, certain limitations apply to recording functions and menu settings. For details, refer to "The camera's setup for the 4K Photo function" (→117).
- In addition to the limitations of the 4K Photo function, the following limitations apply to [Post Focus] recording:
 - [AF Mode] and [AFS/AFF/AFC] cannot be set.
 - Manual Focus cannot be used.
 - The following [Custom] menu items cannot be set: [Shutter AF]
 - Videos cannot be recorded.
 - [Digital Zoom] is not available.
- During recording, the recorded area is slightly smaller than usual.
- The [Post Focus] function is disabled when using the following settings:
 - [Clear in Backlight], [Glistening Water], [Artistic Nightscape], [Glittering Illuminations], [Handheld Night Shot], [Clear Night Portrait], [Soft Image of a Flower] (Scene Mode)
 - [Rough Monochrome], [Silky Monochrome], [Miniature Effect], [Soft Focus], [Star Filter], [Sunshine] (Creative Control Mode)
 - When [Multi Exp.] is set
 - When using [Time Lapse Shot]
 - When using [Stop Motion Animation]
- When selecting the focus and saving pictures, you cannot select and save the picture from a TV screen even if the camera is connected to a TV through an HDMI micro cable.
- In the following cases, [Focus Stacking] may produce an unnatural picture:
 - If the subject is in motion
 - If there are large differences in distance to the subject
 - If there is significant blurring (recording with a larger aperture might make the picture less unnatural)
- During focus stacking, auto compensation is applied to deviations among pictures due to camera shake. In such cases, the recorded area will be slightly smaller than at the time of focus stacking.
- Only pictures taken using [Post Focus] on this camera are eligible for [Focus Stacking].

Selecting a Drive Mode

Recording modes: **A** **A** **P** **A** **S** **M** **M** **SCN** **COL**

You can change what the camera will do when you press the shutter button.

1 Press [] (▼)

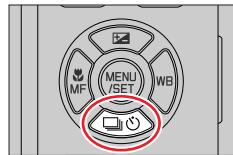

2 Press ◀▶ to select the drive mode and then [MENU/SET]

Ⓐ Drive Mode

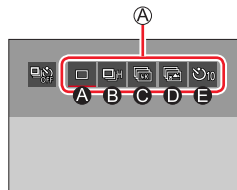

A [Single]	When the shutter button is pressed, only one picture is recorded.
B [Burst] (→125)	Pictures are taken in succession as long as the shutter button is pressed.
C [4K PHOTO] (→108)	When the shutter button is pressed, a picture is recorded with the 4K Photo function.
D [Post Focus] (→119)	When the shutter button is pressed, the pictures are recorded with [Post Focus].
E [Self Timer] (→127)	When the shutter button is pressed, recording takes place after the set time has elapsed.

■ To cancel the drive mode

In step 2, select [] ([Single]) or [OFF].

- You can cancel the self-timer by turning off the camera. (When [Self Timer Auto Off] is set to [ON].)

Continuous exposure function

■ Setting [Burst Rate]

- ① Select [Burst] and press ▲ in step 2 (→124)
- ② Select the frame rate with ◀▶, and press [MENU/SET]

		[H] (High speed)	[M] (Middle speed)	[L] (Low speed)
Frame rate (pictures/sec.)	[AFS] / [MF]	10	7	2
	[AFF] / [AFC]	6	6	
Live View during serial recording	[AFS] / [MF]	None	Available	Available
	[AFF] / [AFC]	Available		
Number of recordable pictures*	With RAW files	28 or more		
	Without RAW files	85 or more		

* When recording is performed under the test conditions specified by Leica Camera AG. Pictures can be taken until the card becomes full. However, the frame rate will become slower halfway through the recording. The number of serial pictures is limited by the picture-taking conditions and the type and/or status of the card used.

■ About the maximum number of pictures that can be taken continuously

When you press the shutter button halfway, the maximum number of pictures you can take continuously will appear. You can check the approximate number of pictures that can be taken before the frame rate slows down.

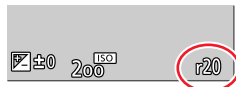

Example: When 20 pictures can be taken: [r20]

- Once recording starts, the maximum number of pictures that can be taken continuously will decrease. When [r0] appears, the frame rate will slow down.
- When [r99+] is displayed, you can take 100 or more pictures continuously.

Selecting a Drive Mode

**Focusing in continuous mode**

Focusing varies depending on focus settings and the setting of [Focus/Release Priority] in the [Custom] ([Focus / Release Shutter]) menu.

Focus settings	[Focus/Release Priority]	[H]	[M], [L]
[AFS]	[FOCUS]/ [BALANCE]/ [RELEASE]	At the first picture	
[AFF] / [AFC]*1	[FOCUS]	Predicted focusing*2	Normal focusing*3
	[BALANCE]/ [RELEASE]	Predicted focusing*2	
[MF]	—	Focus set with Manual Focus	

*1 Focus is fixed in the first picture when dark subjects are recorded.

*2 The camera predicts the focus within a possible range by giving higher priority to the frame rate.



*3 Since the camera records a series of pictures while it adjusts the focus, the frame rate may be slower.

- The frame rate may become slower depending on the following settings: [Sensitivity], [Picture Size], [Quality], [AFS/AFF/AFC], [Focus/Release Priority]
- When the frame rate is set to [H] (when [AFS/AFF/AFC] is set to [AFS] or when the focus mode is set to [MF]), the exposure and White Balance are fixed to those of the first picture. When the frame rate is set to [H] (when [AFS/AFF/AFC] is set to [AFF] or [AFC]), [M], or [L], the exposure and White Balance are adjusted individually for each picture.
- **It may take a while to store pictures that were taken using the continuous function. If you continue to record while storing, the number of serial pictures that can be taken will be reduced. A high-speed card is recommended when recording using the continuous function.**
- This function is not available in the following cases:
 - [Glistening Water], [Glittering Illuminations], [Handheld Night Shot], [Soft Image of a Flower] (Scene Mode)
 - [Rough Monochrome], [Silky Monochrome], [Miniature Effect], [Soft Focus], [Star Filter], [Sunshine] (Creative Control Mode)
 - When recording using the flash
 - When [Multi Exp.] is set
 - When using [Time Lapse Shot]
 - When [Auto Shooting] of [Stop Motion Animation] is set to [ON]

Taking pictures with the self-timer

■ Setting the self-timer operation

- ① Select [Self Timer] and press ▲ in step 2 (→124)
- ② Select the self-timer operation with ◀▶, and press [MENU/SET]

	The shutter is activated after 10 seconds.
	The shutter is activated after 10 seconds and three pictures are taken at intervals of approximately 2 seconds.
	The shutter is activated after 2 seconds. This is also effective for preventing camera shake when pressing the shutter button.

- After the self-timer indicator flashes, recording will start.
- The focus and exposure are fixed when the shutter button is pressed halfway.
- We recommend using a tripod.
- [Self-Timer] cannot be set in the following cases:
 - When recording using [Bracket]
 - When [Multi Exp.] is set
 - When [Simultaneous Record w/o Filter] of [Filter Settings] is set to [ON]
- This function is not available in the following cases:
 - During video recording
 - When using [Time Lapse Shot]
 - When [Auto Shooting] of [Stop Motion Animation] is set to [ON]

Taking Picture Series with Automatically Changing Settings (Bracket Recording)

Recording modes:

You can create a series of pictures in which a range of preset setting changes is applied automatically after pressing the shutter button.

1 Set the menu

MENU → **[Rec]** → **[Bracket]** → **[Bracket Type]**

(Exposure Bracket)	Pressing the shutter button creates a series of pictures with differing exposure. (→129)
(Aperture Bracket)	Pressing the shutter button creates a series of pictures with differing aperture settings. (→130) • Available in Aperture-Priority Mode or when the ISO sensitivity is set to [AUTO] in Manual Exposure Mode.
(Focus Bracket)	Pressing the shutter button creates a series of pictures with differing focus settings. (→130)
(White Balance Bracket)	Pressing the shutter button creates a series of 3 pictures with differing White Balance settings. (→107)

2 Press ▼ to select [More Settings] and then [MENU/SET]

- For information on [More Settings], refer to the page that describes each function.
- Press the shutter button halfway to exit the menu.

3 Focus on the subject and take a picture

- When Exposure Bracket is selected, the bracket display flashes until all of the pictures you have set are taken. If you change the bracket settings or turn off the camera before all of the pictures you have set are taken, the camera restarts recording from the first picture.

■ To cancel [Bracket]

Select [OFF] in step 1.

Taking Picture Series with Automatically Changing Settings (Bracket Recording)

- Bracket recording is disabled in the following cases.
 - [Glistening Water], [Glittering Illuminations], [Handheld Night Shot], [Soft Image of a Flower] (Scene Mode)
 - [Rough Monochrome], [Silky Monochrome], [Miniature Effect], [Soft Focus], [Star Filter], [Sunshine] (Creative Control Mode)
 - When recording using the flash (except for White Balance Bracket)
 - When recording videos
 - When recording 4K photos
 - When recording using [Post Focus]
 - When [Multi Exp.] is set
 - When using [Time Lapse Shot]
 - When [Auto Shooting] of [Stop Motion Animation] is set to [ON]

Exposure Bracket

■ About [More Settings] (step 2 in (→128))

[Step]	Sets the number of pictures to be taken and the exposure compensation range. [3•1/3] (Takes three pictures with an interval of 1/3 EV) to [7• 1] (Takes seven pictures with an interval of 1 EV)
[Sequence]	Sets the order in which pictures are taken.
[Single Shot Setting]*	[□]: Takes one picture each time you press the shutter button. [☑]: Takes all the pictures set to be taken after you press the shutter button once.

* Not available for continuous recording. When using this function, if you press and hold the shutter button, recording will be performed continuously until a specified number of pictures are taken.

[Step]: [3•1/3], [Sequence]: [0/-/+]

1st picture

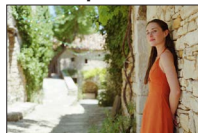

±0 EV

2nd picture

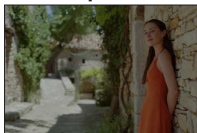

-1/3 EV

3rd picture



+1/3 EV

- When taking pictures using Exposure Bracket after setting the Exposure Compensation value, the pictures taken are based on the selected Exposure Compensation value.

Taking Picture Series with Automatically Changing Settings (Bracket Recording)

Aperture Bracket

Recording modes: **A** **M**

■ About [More Settings] (step 2 in (→128))

[Image Count]	[3]: Takes a specified number of pictures with different aperture values within the range based on the initial aperture value. [ALL]: Takes pictures using all aperture values.
---------------	--

- When using continuous recording, if you press and hold the shutter button, recording will be performed until a specified number of pictures are taken.

Example:

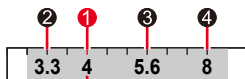

When the initial position is set to F4:

- ① first picture, ② second picture, ③ third picture, ④ fourth picture

Focus Bracket

■ About [More Settings] (step 2 in (→128))

[Step]	Sets the interval between focus positions.
[Image Count]*	Sets the number of pictures to be taken.
[Sequence]	[0/-/+]: Takes pictures with different focus positions within the range based on the initial focus position. [0/+]: Takes pictures with different focus positions toward the far side based on the initial focus position.

* Not available for continuous recording. When using this function, if you press and hold the shutter button, recording will be performed continuously until a specified number of pictures are taken.

[Sequence]: Example when [0/-/+]
[Sequence]: Example when [0/+]



Ⓐ Close-up

Ⓑ Infinity

- ① first picture, ② second picture... ⑤ fifth picture...

- Pictures taken with Focus Bracket are displayed as a set of group pictures.

Taking Pictures Automatically at Set Intervals

[Time Lapse Shot]

Recording modes: [A] [A+] [P] [A] [S] [M] [M] [SCN] [COL]

The camera can automatically create a picture series of subjects such as animals or plants as time elapses. To use this function, set the start time, the time between the shots and the number of pictures. The pictures are recorded as a single group picture.

- Complete the date and time settings in advance. (→28)

1 Set the menu

MENU → [Rec] → [Time Lapse Shot]

[Shooting Interval Setting]	[ON]: Sets the time from recording start time to the next recording start time. [OFF]: After recording is finished, the next recording is started without any interval.	
[Start Time]	[Now]	Starts the recording by fully-pressing the shutter button.
	[Start Time Set]	Any time up to 23 hours 59 minutes ahead can be set. ① Press ◀▶ to select the item (hour and/or minute), and ▲▼ to set the start time, and then [MENU/SET]
[Image Count] / [Shooting Interval]*1	◀▶ : Select the item (digit) ▲▼ : Setting [MENU/SET]: Set	

*1 Can be set only when [Shooting Interval Setting] is set to [ON].

- The estimated recording ending time is displayed on the setting screen. (When [Shooting Interval Setting] is set to [OFF], the recording ending time is displayed only when the focus mode is set to [MF] in Shutter-Priority Mode or Manual Exposure Mode.)
- The camera may not be able to record using the pre-set interval and number of pictures to be recorded or may not finish recording at the estimated recording ending time under some recording conditions.



2 Press ▲ to select [Start] and then [MENU/SET]

3 Press the shutter button halfway to focus

Taking Pictures Automatically at Set Intervals [Time Lapse Shot]

4 Press the shutter button fully

- The recording starts automatically.
- During recording standby, the camera turns off automatically when no operation is performed for a preset interval. The [Time Lapse Shot] recording will continue even if the camera is turned off, and it is automatically turned on at the recording start time. If you want to turn on the camera manually, press the shutter button halfway.
- Operations during recording standby (The camera is turned on)

Operation	Touch operation	Description
[Fn1]*2	 *3	Displays a selection screen that lets you pause or stop the recording
		Displays a selection screen that lets you resume or stop the recording (during pause)

*2 When you record pictures by setting [Shooting Interval Setting] to [OFF], you can press [Fn1] even while recording is in progress. After recording (exposure) of a picture taken at the time when you pressed [Fn1] is finished, a selection screen is displayed.

*3 When you record pictures by setting [Shooting Interval Setting] to [OFF], you cannot perform touch operation.

5 Select the video creation method

[Rec Quality]	Sets the resolution of the video.
[Frame Rate]	Set the number of frames per second. The higher the number is, the smoother the video will be.
[Sequence]	[NORMAL]: Stitches the pictures in the recording sequence. [REVERSE]: Stitches the pictures in the reverse order of recording.

6 Press ▲ to select [OK] and then [MENU/SET]

- You can also create a video using [Time Lapse Video] in the [Playback] menu.

Taking Pictures Automatically at Set Intervals [Time Lapse Shot]

- This function is not intended for application-specific systems (monitoring cameras).
- When using the lens' zoom function, the camera could tilt when the lens barrel extends. Make sure to immobilize the camera with a tripod or by other means.
- [Time Lapse Shot] is paused in the following cases:
 - When the remaining battery power runs out
 - Turning the camera offIf the number of pictures set has not been taken yet, you can restart the operation by turning off the camera in the pause state, replacing the battery or card, and then turning the camera on again. (Note, however, that the pictures recorded after restarting the operation are saved as a separate set of group pictures.)
- We recommend using autofocus for time lapse recording in cases where a long [Shooting Interval] is set and the camera will turn off automatically between shots.
- When creating videos at a resolution of [4K], recording times are limited to 29 minutes. If using an SDHC memory card, you will not be able to create videos with a file size greater than 4 GB. With an SDXC memory card, you can create videos with a file size greater than 4 GB.
- When creating a video with a picture quality size of [FHD] or [HD], you will be unable to create it if the recording time is more than 29 minutes or the file size is greater than 4 GB.
- This function is not available in the following cases:
 - [Handheld Night Shot] (Scene Mode)
 - When [Multi Exp.] is set
 - When using [Stop Motion Animation]

Creating stop motion animation [Stop Motion Animation]

Recording modes:

You can create a video by connecting a series of single pictures. The pictures are recorded as a group.

- Complete the date and time settings in advance. (→28)

1 Set the menu

MENU → [Rec] → [Stop Motion Animation]

[Auto Shooting]	[ON]: Takes pictures automatically at a set recording interval. [OFF]: Takes pictures manually, one frame at a time.
[Shooting Interval]	(Only when [Auto Shooting] is set to [ON]) Set the interval used for [Auto Shooting].

2 Press ▲ to select [Start] and then [MENU/SET]

3 Press ▲ to select [New] and then [MENU/SET]

4 Press the shutter button halfway to focus

5 Press the shutter button fully

- Up to 9,999 frames can be recorded.

6 Move the subject for the next situation

- Repeat the recording of pictures in the same way.
- When you turn off the camera during recording, a message to restart recording will appear when you turn on the camera.



How to create stop motion animation effectively

- Up to two previously recorded pictures are displayed on the recording screen. Check this screen as a guideline for determining the amount of required motion.
- You can press [▶] (Playback) to check the recorded pictures. Press [⏏] to delete unnecessary pictures. To return to the recording screen, press [▶] (Playback) again.

Creating stop motion animation [Stop Motion Animation]

7 Touch [] to end the recording

- You can also end the recording by selecting [Stop Motion Animation] in the [Rec] menu, and then pressing [MENU/SET].
- When [Auto Shooting] is set to [ON], select [End] on the confirmation screen. (If you select [Pause], press the shutter button fully to resume recording.)

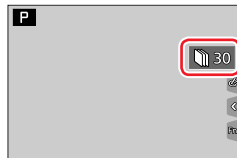
**8 Select a method to create a stop motion animation**

[Rec Quality]	Sets the resolution of the video.
[Frame Rate]	Set the number of frames per second. The higher the number is, the smoother the video will be.
[Sequence]	[NORMAL]: Connects the pictures in the recording sequence. [REVERSE]: Connects the pictures in the reverse order of recording.

9 Press ▲ to select [OK] and then [MENU/SET]

- You can also create a stop motion animation using [Stop Motion Video] in the [Playback] menu.

■ Adding pictures to an already recorded stop motion animation group

When you select [Additional] in step **3**, group pictures recorded using [Stop Motion Animation] are displayed. Select a set of group pictures and press [MENU/SET]. Then, select [Yes] on the confirmation screen.

Creating stop motion animation [Stop Motion Animation]



- [Auto Shooting] may not be performed according to the preset interval because recording could take time under some recording conditions, such as when pictures are taken using a flash.
- When creating videos at a resolution of [4K], recording times are limited to 29 minutes.
If using an SDHC memory card, you will not be able to create videos with a file size greater than 4 GB. With an SDXC memory card, you can create videos with a file size greater than 4 GB.
- When creating a video with a picture quality size of [FHD] or [HD], you will be unable to create it if the recording time is more than 29 minutes or the file size is greater than 4 GB.
- You cannot select only one recorded picture using [Additional].
- This function is not available in the following cases:
 - When [Multi Exp.] is set
 - When using [Time Lapse Shot]
- [Auto Shooting] in [Stop Motion Animation] cannot be used in the following case:
 - [Handheld Night Shot] (Scene Mode)

Compensating Camera Shake

Recording modes:        

This function automatically detects and compensates camera shake.

MENU →  **[Rec]** /  **[Motion Picture]** → **[Stabilizer]**

 (Normal)	Corrects vertical and horizontal camera shake.
 (Panning)	Corrects vertical camera shake. This setting is ideal for panning (technique of recording a subject by matching the camera movement with the movement of a subject going in a specific direction).
[OFF]	[Stabilizer] does not work.



To prevent camera shake

If the camera shake warning is displayed, use [Stabilizer], a tripod, or [Self Timer].

- Using a slower shutter speed can cause motion blur. The shutter speed will be slower particularly in the following cases. Keep the camera still from the moment the shutter button is pressed until the picture appears on the screen. We recommend using a tripod.
 - [Slow Sync.]
 - [Slow Sync./Red-Eye]
 - [Clear Nightscape], [Cool Night Sky], [Warm Glowing Nightscape], [Artistic Nightscape], [Glittering Illuminations], [Clear Night Portrait] (Scene Mode)



Compensating Camera Shake

- When you use a tripod, we recommend setting [Stabilizer] to [OFF].
- [Stabilizer] cannot be used by selecting [(👁️)] (Normal) in Panorama Shot Mode.
- In the following cases, the [Stabilizer] will switch to [(👁️)] (Normal), even if it is set to [(👁️)] (Panning):
 - During video recording
 - When recording 4K photos
 - When recording using [Post Focus]
- [Stabilizer] cannot be used when recording with [High Speed Video].
- The 5-axis Hybrid Image Stabilizer function automatically functions while recording videos. This decreases the camera shake of the image when recording videos while zooming or walking, etc.
 - The recorded area is slightly smaller than usual.
- In the following cases, the 5-axis Hybrid Image Stabilizer function is not available.
 - When using the Digital Zoom
 - When recording videos with [Rec Quality] set to [4K/100M/30p] or [4K/100M/24p]
 - When recording using [4K Live Cropping]
- Cases where the stabilizer function may be ineffective:
 - When there is a lot of camera shake
 - With longer focal lengths (also with high magnification in the Digital Zoom range)
 - When taking pictures while following a moving subject
 - When the shutter speed becomes slower to take pictures indoors or in dark places
- The panning effect by selecting [(👁️)] is not fully achieved in the following cases:
 - Bright summer days or other bright locations
 - When the shutter speed is higher than 1/100 second
 - When the motion of a subject is slow and the speed with which the camera is moved is too slow (a nice background blur is not achieved)
 - When the camera is not adequately tracking the motion of a subject

Using the Lens' Zoom Function

Zoom types and use



The magnification, or zoom ratios mentioned throughout these instructions and for the different settings below are based on that of the shortest focal length / maximum Wideangle setting, which is determined as 1x.

Optical Zoom

Recording modes:

You can zoom in without degrading the picture quality.

Maximum magnification: 15x

- This function is not available in the following case:
 - When recording with [Macro Zoom]

Extended optical zoom

Recording modes:

This function works when resolutions with [EX] have been selected in [Picture Size]. Extended optical zoom allows you to zoom in using a higher zoom ratio than Optical Zoom, without degrading the picture quality. The maximum zoom ratio varies depending on the resolution.

Maximum magnification: 30x (Including the optical zoom ratio.)

- This function is not available in the following cases:
 - [Handheld Night Shot] (Scene Mode)
 - [Toy Effect], [Toy Pop] (Creative Control Mode)
 - When recording 4K photos
 - When recording using [Post Focus]
 - When [HDR] is set to [ON]
 - When [Multi Exp.] is set
 - When [iHandheld Night Shot] is set to [ON]
 - When [iHDR] is set to [ON]
 - When [Quality] is set to [RAW]
 - When recording with [Macro Zoom]
 - During video recording

Using the Lens' Zoom Function

[i.Zoom]

Recording modes: P A S M COL

You can use the camera's Intelligent Resolution technology to increase the zoom ratio up to 2x higher than the original ratio with limited deterioration of resolution.

MENU → **[Rec]** / **[Motion Picture]** → **[i.Zoom]**

Settings: [ON] / [OFF]

- When [Picture Size] is set to [S], the zoom ratio can be increased to up to 1.5x the original ratio.
- [i.Zoom] works automatically in Snapshot Mode or Snapshot Plus Mode.
- This function is not available in the following cases:
 - [Handheld Night Shot] (Scene Mode)
 - [Impressive Art], [Toy Effect], [Toy Pop] (Creative Control Mode)
 - When recording with [Macro Zoom]
 - When [HDR] is set to [ON]
 - When [Multi Exp.] is set
 - When [iHandheld Night Shot] is set to [ON]
 - When [iHDR] is set to [ON]
 - When [Quality] is set to [RAW], [RAW] or [RAW]

Using the Lens' Zoom Function

[Digital Zoom]

Recording modes: **A A P A S M M** **SCN COL**

Allows you to zoom 4x further than Optical/Extended optical zoom. When [Digital Zoom] is used simultaneously with [i.Zoom], you can increase the combined zoom ratio up to 4x.

Note that, with Digital Zoom, enlarging will decrease resolution.

MENU → **[Rec]** / **[Motion Picture]** → **[Digital Zoom]**

Settings: [ON] / [OFF]

- When using [Digital Zoom], we recommend using a tripod and the self-timer (→127).
- The AF area is largely displayed at the center in the Digital Zoom range.
- This function is not available in the following cases:
 - When [Monitor Display Speed] is set to [ECO 30fps] (setting at the time of purchase)
 - When [EVF Display Speed] is set to [ECO 30fps]
 - [Handheld Night Shot] (Scene Mode)
 - [Impressive Art], [Toy Effect], [Toy Pop], [Miniature Effect] (Creative Control Mode)
 - When recording using [Post Focus]
 - When recording with [High Speed Video]
 - When [HDR] is set to [ON]
 - When [Multi Exp.] is set
 - When [Quality] is set to [RAW], [RAW] or [RAW]

The illustration is an example of when using Optical Zoom, [i.Zoom], and [Digital Zoom] in Program Mode.

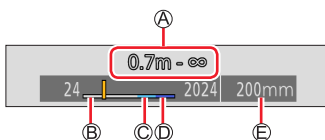

- Ⓐ Focusing range
- Ⓑ Optical Zoom range
- Ⓒ i.Zoom range
- Ⓓ Digital Zoom range
- Ⓔ Current zoom position (Focal lengths the same as those of a 35 mm film camera)

Using Touch zoom

1 Touch [◀]

2 Touch [T/W↑]

- The slide bar is displayed.

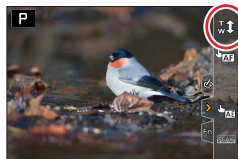

3 Perform zoom operations by dragging the slide bar

- The zoom speed varies depending on the touched position.

[▼] / [▲]	Slow zooming
-----------	--------------

[▼] / [▲]	Fast zooming
-----------	--------------

- Touch [T/W↑] again to end touch zoom operations.



Taking Pictures with the Built-In Flash

Recording modes: **A** **A** **P** **A** **S** **M** **M** **SCN** COL

■ Open/Close the flash

A To open the flash

Slide the flash release lever.

- Be careful when opening the flash as it will jump out.

A

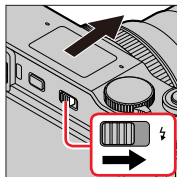

B To close the flash

Press it down until it clicks into place.

- Be careful not to catch a finger or any other part of your body or any object when you close the flash.
- Using force against any resistance to close the flash can damage the camera.
- Be sure to close the flash when not in use.
- The flash setting is fixed to **[3]** (Forced Flash Off) while the flash is closed.

B

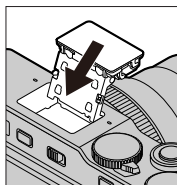







Changing the Flash Control Mode

Recording modes: **A** **A** **P** **A** **S** **M** **M** **SCN** COL

This function allows you to select the flash mode to match the situation.

MENU →  **[Rec]** → **[Flash]** → **[Flash Mode]**

<p> : [Forced Flash On]</p> <p> : [Forced On/Red-Eye]</p>	<p>The flash is fired every time regardless of the recording conditions.</p> <ul style="list-style-type: none"> • Use these modes when your subject is back-lit or under fluorescent light.
<p> S : [Slow Sync.]</p> <p> : [Slow Sync./Red-Eye]</p>	<p>When taking pictures of dark subjects, this feature will use slower shutter speeds when the flash is fired, so dark backgrounds will appear brighter.</p> <ul style="list-style-type: none"> • Ideal for taking pictures of people against a nightscape. • Using a slower speed can cause motion blur. We recommend using a tripod.

The flash is fired twice. The interval between the first and second flash is longer when [] or [] is set. The subject should not move until the second flash is fired.

- The red-eye reduction effect varies depending on the subject and is affected by factors such as distance from the subject and whether the subject is looking at the camera during the preliminary flash. In some cases, red-eye reduction may be negligible.

Taking Pictures with the Built-In Flash

■ Flash settings for each exposure control mode (○: Available, –: Not available)

Exposure control mode*1					
P	Program Mode	○	○	○	○
A	Aperture-Priority Mode	○	○	○	○
S	Shutter-Priority Mode	○	○	–	–
M	Manual Exposure Mode	○	○	–	–
SCN Scene Modes (●: Default settings)	[Clear Portrait]	○	●	–	–
	[Silky Skin]	○	●	–	–
	[Clear in Backlight]	●	–	–	–
	[Sweet Child's Face]	○	●	–	–
	[Clear Night Portrait]	–	–	–	●
	[Soft Image of a Flower]	●	–	–	–
	[Appetizing Food]	●	–	–	–
	[Cute Dessert]	●	–	–	–
	[Freeze Animal Motion]	●	–	–	–
	[Clear Sports Shot]	●	–	–	–
[Monochrome]	●	○	○	○	

*1 For details about flash settings in Snapshot Mode ([**A**] or [**A**]), refer to (→52).

- The flash is fixed to [] (Forced Flash Off) in the following cases:
 - [Backlit Softness], [Relaxing Tone], [Distinct Scenery], [Bright Blue Sky], [Romantic Sunset Glow], [Vivid Sunset Glow], [Glistening Water], [Clear Nightscape], [Cool Night Sky], [Warm Glowing Nightscape], [Artistic Nightscape], [Glittering Illuminations], [Handheld Night Shot] (Scene Mode)
 - During video recording
 - When recording 4K photos
 - When recording using [Post Focus]
 - **When using the electronic shutter**
 - When [HDR] is set to [ON]
 - **When [Silent Mode] is set to [ON]**
 - When a picture effect in [Filter Effect] of [Filter Settings] is set
- The Scene Mode flash setting is returned to the initial value with each change of scene.

Taking Pictures with the Built-In Flash

■ Shutter speeds for each flash control mode

Flash control mode	Shutter speed (seconds)	Flash control mode	Shutter speed (seconds)
	1/60*2 - 1/2000		1 - 1/2000

*2 The shutter speed is set to 60 seconds in Shutter-Priority Mode. The shutter speed is set to T (Time) in Manual Exposure Mode.

- In Snapshot Mode ([] or []), the shutter speed changes depending on the detected scene.

■ The available flash range

The edges of a picture may become slightly dark if using flash at short distances and the lens' short focal lengths (close to max. Wide). This may be remedied by using slightly longer focal lengths.

Max. Wide angle setting	Max. Tele setting
Approx. 0.6 m - 6.8 m (2' - 22')	Approx. 1.0 m - 3.9 m (3'3" - 13')

- These ranges are obtained, provided the ISO sensitivity is set to [AUTO], and [ISO Auto Upper Limit (Photo)] is set to [AUTO].

- Avoid doing the following, as the heat or light could cause deformation or discoloration.
 - Using the flash at close range
 - Covering the flash with your hand as it is firing
 - Closing the flash as it is firing
- Do not close the flash immediately after the preliminary flash is fired prior to taking pictures for Forced ON/Red-Eye Reduction and other flash settings. If you close the flash immediately, it will cause a malfunction.
- Flash charging may take longer if the battery is depleted or if using flash repeatedly. When the flash is being charged, the flash icon flashes red, and you cannot take a picture even when you fully press the shutter button.



Taking Pictures with the Built-In Flash

2nd curtain sync

Recording modes: **A A P A S M** **M** **SCN** COL

2nd curtain sync fires the flash at the end of the exposure as opposed to the normal firing time (at the beginning of the exposure). This can be utilized to create a certain effect (especially with slower shutter speeds, see below).

MENU → **[Rec]** → **[Flash]** → **[Flash Synchro]**

[1ST]	1st curtain sync is the normal recording method when using the flash.	
[2ND]	The light source appears behind the subject, making the picture appear more logical.	

- If you set to [2ND], [2nd] will be displayed in the flash icon on the screen.
- When a fast shutter speed is set, the [Flash Synchro] effect may not be sufficiently achieved.
- When [2ND] is set, you cannot set the flash setting to [$\frac{1}{2}$ ⊙] or [$\frac{1}{5}$ ⊙].

Flash exposure compensation

Recording modes: **A A P A S M** **M** **SCN** COL

You can adjust the flash exposure to compensate for pictures in which the parts mainly illuminated by the flash would otherwise appear too dark or bright.

MENU → **[Rec]** → **[Flash]** → **[Flash Adjust.]**

1 Press ◀▶ to set the flash output and then [MENU/SET]

Settings: -2 EV to +2 EV (increment: 1/3 EV)

When you do not want to adjust the flash exposure, select [±0 EV].

- When the flash exposure is compensated, [+] or [-] is displayed on the flash icon.

Recording Videos/4K Videos

Recording modes: 

Videos, including those taken in 4K, are recorded in the MP4 format. (→150)
Audio is recorded in stereo.

1 Press the video button to start recording

- Ⓐ Recording state indicator
- Ⓑ Elapsed recording time
- Ⓒ Remaining recording time

- Recording of videos appropriate for each video mode is possible.
- Immediately release the video button after pressing it.
- While you are recording videos, the recording status indicator (red) will flash.

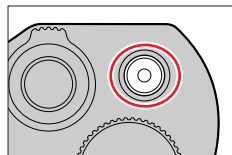
**2 Press the video button again to end recording**

- **With recording in a quiet environment, the sound of aperture setting, focusing and other actions may be recorded in videos. This is not a malfunction.**

The focus operation during video recording can be set to [OFF] in [Continuous AF]. (→151)

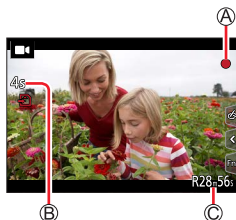
**About operation sound when recording ends**

If the operation sound of the video button pressed to end recording bothers you, try the following:

- Record the video about three seconds longer, and then cut off the last part of the video using [Video Divide] (→221) in the [Playback] menu.

Recording videos in Creative Video Mode

You can record a video by setting the aperture, shutter speed, and ISO sensitivity using touch operation. (→77)

Recording Videos/4K Videos

- If the surrounding temperature is high, or a video is recorded continuously, [△] is displayed and recording may be stopped halfway through. Wait until the camera cools down.
- Note that if you perform operations such as zoom, using buttons or dials, while recording a video, operation noise may be recorded.
- If Extended optical zoom is used before pressing the video button, these settings will be cleared, and the recordable area will be changed significantly.
- If the aspect ratio is different for pictures and videos, the captured area will change when starting to record a video.
When you set [Rec Area] to [■], the angle of view setting used for recording videos is displayed.
- The zoom speed will be slower than normal during video recording.
- Depending on the type of the card, the card access indication may appear for a while after recording video. This is not a malfunction.
- ISO sensitivity is set to [AUTO] (for video) while a video is being recorded. You can set ISO sensitivity and record video in Creative Video Mode.
- The below-mentioned video recording modes are set in the following cases:

Selected Scene Mode	Recording mode at the time of recording videos
[Clear in Backlight]	Portrait Mode
[Clear Nightscape], [Artistic Nightscape], [Handheld Night Shot], [Clear Night Portrait]	Low Light Mode

- This function is not available in the following cases:
 - [Glistening Water], [Glittering Illuminations], [Soft Image of a Flower] (Scene Mode)
 - [Rough Monochrome], [Silky Monochrome], [Soft Focus], [Star Filter], [Sunshine] (Creative Control Mode)
 - When [Post Focus] is set
 - When using [Time Lapse Shot]
 - When using [Stop Motion Animation]

Setting the resolution and the frame rate

MENU → [Motion Picture] → [Rec Quality]

[Rec Quality]	Resolution	Frame rate	Bit rate
[4K/100M/30p]*	3840×2160	30p	100 Mbps
[4K/100M/24p]*	3840×2160	24p	100 Mbps
[FHD/28M/60p]	1920×1080	60p	28 Mbps
[FHD/20M/30p]	1920×1080	30p	20 Mbps
[HD/10M/30p]	1280×720	30p	10 Mbps

* 4K videos

- The quality becomes higher when the number of bit rate gets bigger. This camera uses the “VBR” recording method, and the bit rate is changed automatically depending on the subject to record. Therefore, the recording time is shortened when a subject with fast movement is recorded.
- 4K video cannot be set when using [Miniature Effect] (Creative Control Mode).
- To record 4K videos, use a UHS Speed Class 3 card.
- When you record 4K videos, the captured area will be slightly smaller than videos of other resolutions.
- To ensure highly accurate focus, 4K videos are recorded at reduced Autofocus speeds. It may be difficult to focus on the subject with Autofocus, but this is not a malfunction.
- For limitations on continuous recording, refer to (→27)

■ About the compatibility of the recorded videos

Videos recorded in the MP4 format may be played back with poor picture or sound quality or playback may not be possible even when played back with equipment compatible with the format. Also, the recording information may not be displayed properly.

- For details on videos recorded with [4K/100M/30p] or [4K/100M/24p] in the [MP4] format, refer to “Viewing 4K videos” (→256).

Focusing while recording videos ([Continuous AF])

Recording modes: **A** **A** **P** **A** **S** **M** **M** **SCN** **COL**

Focusing varies depending on the setting of focus and the setting of [Continuous AF] in the [Motion Picture] menu.

MENU → **■** **[Motion Picture]** → **[Continuous AF]**

Focus setting	[Continuous AF]	Setting
[AFS]/[AFF]/[AFC]	[ON]	Allows the focus to be constantly adjusted automatically while recording videos.
	[OFF]	Fixes focus position at the start of video recording.
[MF]	[ON] / [OFF]	Allows the focus to be adjusted manually.

- When the focus setting is set to [AFS], [AFF], or [AFC], the camera will refocus if the shutter button is pressed halfway while recording videos.
- When Autofocus is activated while you are recording videos, the focusing operation sound may be recorded under some conditions. If you want to suppress this sound, we recommend taking pictures after setting [Continuous AF] to [OFF].
- If you change the zoom lens' focal length while recording videos, it may take some time to focus.
- This function is not available in the following cases:
 - While [Pull Focus] in [Snap Movie] is in operation.
 - When recording with [High Speed Video]
 - When recording using [4K Live Cropping]

Taking Pictures While a Video is Being Recorded

Recording modes: 

1 Press the video button fully during the recording

- The simultaneous recording indicator is displayed while recording pictures.
- Recording with the Touch Shutter function is also available.



- Pictures will be recorded with a resolution determined by the [Rec Quality] setting for videos.
- Up to 40 pictures can be recorded during recording of the video.
(A video with a [Rec Quality] size of [4K]: up to 10 pictures)
- The aspect ratio of a picture is fixed to [16:9].
- Only pictures in JPEG file format are recorded when [Quality] is set to [RAW], [RAW], or [RAW].
([Quality] is used with the [RAW] setting when [RAW] is set.)
- This function is not available in the following case:
 - When [Snap Movie] is set to [ON]

Recording Snap Videos

Recording modes: **A A P A S M M** **SCN COL**

You can specify the recording time in advance and record videos casually like you take snapshots. The function also allows you to shift a focus at the start of recording and add fade in/out effects in advance.

- The videos will be recorded with [FHD/20M/30p] in [MP4].

MENU → **▶** **[Motion Picture]** → **[Snap Movie]** → **[ON]**

- Press the shutter button halfway to exit the menu.

1 Press the video button to start recording

- Ⓐ Elapsed recording time
- Ⓑ Set recording time

- Immediately release the video button after pressing it.
- You cannot stop video recording in the middle.
The recording will stop automatically when the set recording time has elapsed.

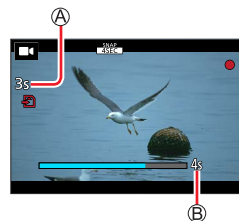

■ Deactivating Snap Video

Set [Snap Movie] to [OFF].

■ Changing the settings

MENU →  **[Motion Picture]** → **[Snap Movie]** → **[SET]**

[Record time]	Sets the recording time of videos.
[Pull Focus]	Allows dramatic imaging expression by shifting focus gradually at the start of recording. (→155)
[Fade]	<p>Adds a fade-in (gradual appearance) effect to an image and audio as recording starts or adds a fade-out (gradual disappearance) effect to them as recording ends.</p> <p>[WHITE-IN] / [WHITE-OUT]: Adds a fade-in or fade-out effect that uses a white screen.</p> <p>[BLACK-IN] / [BLACK-OUT]: Adds a fade-in or fade-out effect that uses a black screen.</p> <p>[COLOR-IN] / [COLOR-OUT]: Adds an effect that fades in from black-and-white to color or an effect that fades out from color to black-and-white. Audio will be recorded normally.</p> <p>[OFF]</p>

- Videos recorded with [WHITE-IN] or [BLACK-IN] are displayed as all-white or all-black thumbnails in Playback Mode.
- If you assign [Snap Movie] to [Fn Button Set] in [Custom] ([Operation]) menu (→46), you can display a screen that lets you switch [Snap Movie] between [ON]/[OFF] by pressing the assigned function button. If you press [DISP] while the screen is displayed, you can change the settings for Snap Video.
- [Snap Movie] will be set to [OFF] when you connect to Wi-Fi with [Remote Shooting & View].
- This function is not available in the following cases:
 - [Miniature Effect] (Creative Control Mode)
 - When [4K PHOTO] is set
 - When [Post Focus] is set
 - When [4K Live Cropping] is set
 - When recording with [High Speed Video]

Setting up [Pull Focus]

Set the frames that specify the positions where the [Pull Focus] starts (first position) and stops (second position).

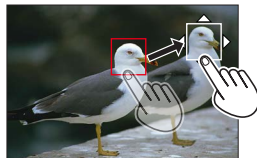

Touch operation

Touch a subject (first position), drag your finger to the desired location (second position), and release the finger.



- To cancel the frame settings, touch .

Button operation

- ① Assign [AF Mode] to a function button ([Fn1] - [Fn4]) (→46)
- ② Press the function button that [AF Mode] was assigned to at step ①
- ③ Press $\blacktriangle \blacktriangledown \blacktriangleleft \blacktriangleright$ to move the frame, and then [MENU/SET] (First position)
 - If you press [DISP] before pressing [MENU/SET], the frame will return to the center.
- ④ Repeat step ③ (Second position)
 - To cancel the frame settings, press [MENU/SET].



- A greater effect can be achieved by creating a striking contrast of focus between the start and end positions, for example by shifting focus from the background to foreground, or vice versa.
- After focusing, try to keep the distance between the subject and the camera constant.

- When the camera fails to set the frame, it returns to the first position.
- When [Pull Focus] is set to [ON]
 - Autofocus Mode will be switched to , a setting specially designed for [Pull Focus].
 - If you take a picture, the Autofocus operation  will take place at the first frame position.
- When [Metering Mode] is set to  (Spot), the spot metering target is fixed at the start position (first position) of [Pull Focus].
- This function is not available in the following cases:
 - In Manual Focus
 - When using Digital Zoom

Viewing your pictures

1 Press [▶] (Playback)

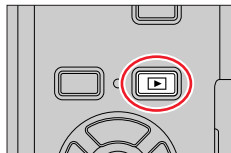

2 Press ◀▶ to select a picture to be displayed

- When you press and hold ◀▶, the pictures are displayed one after another.
- Pictures can also be forwarded or rewound by rotating the thumb dial or dragging the screen horizontally.
- If you keep your finger touching the left or right edge of the screen after scrolling the pictures, the pictures will continue to be scrolled. (The pictures are displayed in a reduced size.)



■ Ending Playback

Press [▶] (Playback) again.

The Playback can also be ended by pressing the shutter button halfway.

- The playback screen appears if the camera is turned on while pressing [▶] (Playback).
- When [Lens Retraction] is set to [ON], the lens barrel is retracted after approx. 15 seconds as the camera is switched to the playback screen from the recording screen.
- This camera is compliant with the unified DCF (Design rule for Camera File system) standard formulated by the Japan Electronics and Information Technology Industries Association (JEITA), and with Exif (Exchangeable image file format). Files that are not DCF-compliant cannot be played back.
- It may not be possible to properly play back pictures taken using other cameras than this one or it may not be possible to use the functions of this camera for those pictures.

Viewing Videos

This camera was designed to play videos using the MP4 format.

- Videos are displayed with the ([▶]) icon.

1 Press ▲ to start playback

Ⓐ Video recording time

- Touching ([▶]) in the middle of the screen allows you to play back videos.
- Videos recorded with [Snap Movie] are played back automatically.



Ⓐ

■ Operations during video playback

Operation	Touch operation	Description
▲	[▶/]	Play / pause
◀	[◀◀]	Fast rewind*
	[◀]	Single-frame rewind (while paused)
▶	[▶▶]	Fast forward*
	[▶]	Single-frame forward (while paused)
▼	[■]	Stop
	[+]	Volume up
	[-]	Volume down

* The fast forward or rewind speed increases if you press ◀▶ again.

■ Operations during automatic Snap Video playback

▲	Playback from the beginning
◀	Returning to the previous picture
▶	Scrolling to the next picture

- If you touch the screen, automatic playback will stop.

● Videos can be viewed on your computer using the software available after registering your camera on the Leica Camera AG home page (→262).

Extracting single frames from videos

1 Display the frame you want to capture as a picture by pressing **▲** to pause a video being played back on the camera

- If you press **◀▶** while paused, you can make finer adjustments to the positions in a video.

2 Press [MENU/SET]

- The same operation can be performed by touching [**⏏**].
- The picture is saved with an aspect ratio of [16:9] and [Quality] of [**⏏**]. The resolution varies depending on the video being played back.



[Rec Quality]	[Picture Size]
[4K]	[M] (8M)
[FHD], [HD]	[S] (2M)

- The resolution can be slightly reduced depending on the [Rec Quality] setting of the original video.
- When a picture captured from a video is played back, [**⏏**] is displayed.



Switching the Playback Method

Zooming in and viewing “Playback Zoom”

1 Move the zoom lever towards the T side

Ⓐ Current zoom position

- Each time you move the zoom lever towards the T side, the magnification increases through four levels: 1x, 2x, 4x, 8x, and 16x.



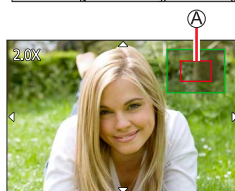
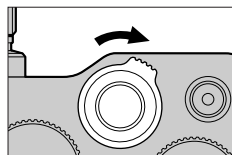

Operation	Touch operation	Description
	—	Enlarges/reduces the screen in large steps.
—	Spread / Pinch	Enlarges/reduces the screen in small steps.
	Drag	Moves the enlarged area (during enlarged display).
	—	Forwards/rewinds a picture while maintaining the same zoom magnification and zoom position (during Playback Zoom).

- You can also zoom in by quickly touching the display twice. (If the display was enlarged, it returns to the same magnification ratio.)



Viewing a list of pictures “Multi Playback”

1 Move the zoom lever towards the W side

- Move the zoom lever towards the W side and you can switch the display methods in the following order: 1-picture screen (full-screen) → 12-picture screen → 30-picture screen → Calendar screen. (Move the lever to the T side to return.)
- It is possible to switch the playback screen by touching the following icons.
 - : 1-picture screen
 - : 12-picture screen
 - : 30-picture screen
 - : Calendar screen (→160)
- The screen can be switched gradually by dragging the screen up or down.
- When you select a picture using the cursor buttons and press [MENU/SET] on the 12-picture or 30-picture screen, the selected picture is displayed on the 1-picture screen (full-screen). (When you select a video, it is automatically played back.)

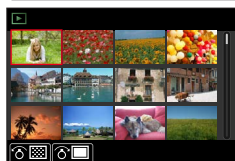
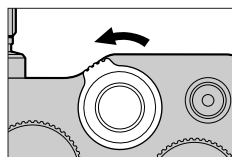

- Pictures displayed with  cannot be played back.

Viewing pictures by their recording date “Calendar Playback”

- 1 Move the zoom lever towards the W side to display the calendar screen

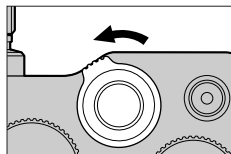

- 2 Use ▲▼◀▶ to select the recording date and press [MENU/SET]

Ⓐ Selected date

- Pictures are displayed in a 12-picture screen.
- Turn the zoom lever towards the W side to return to the Calendar screen display.

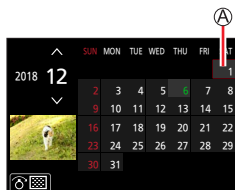

- You can display the calendar between January 2000 to December 2099.
- Pictures taken without clock settings are displayed with the date 1st January, 2018.
- Pictures taken with destination settings made in [World Time] are displayed in the calendar screen using the appropriate date for the destination's time zone.

Viewing group pictures

You can consecutively play back multiple pictures in a group or play back group pictures one by one.

[]: Group picture saved using [4K PHOTO Bulk Saving]

[]: Group pictures recorded using Focus Bracket

[]: Group pictures recorded using [Time Lapse Shot]

[]: Group pictures recorded using [Stop Motion Animation]



- You can delete or edit pictures in group units. (For example, if you delete one of pictures in a group, all pictures in that group will be deleted.)

● Pictures will not be grouped if they are recorded without setting [Clock Set].

Playing back group pictures consecutively

1 Press ▲

- The same operation can be performed by touching the group picture icon ([], [], []).
- When you play back group pictures one by one, the option settings are displayed.

[From the first picture]: Play back the group pictures consecutively from the first picture in a group.

[From the current picture]: Play back the group pictures consecutively from the picture currently played back.

■ Operations during continuous playback

Operation	Touch operation	Description	Operation	Touch operation	Description
▲		Continuous playback / Pause	▼		Stop
◀		Fast rewind playback	▶		Fast forward playback
		Returning to the previous picture (while paused)			Scrolling to the next picture (while paused)

Playing back group pictures one by one

1 Press ▼

- The same operation can be performed by touching [◀] / [▶] / [◀] / [▶].

2 Use ◀▶ to scroll through the pictures

- Pressing ▼ again or touching [▶] will return you to the normal playback screen.
- You can use the same operations for pictures stored in a group as in normal picture playback. (Multi Playback, Playback Zoom, deletion of pictures, etc.)



Deleting pictures

Deleted pictures cannot be recovered.

[Delete Single]

1 Press [Fn] to delete displayed picture

- The same operation can be performed by touching [Fn].

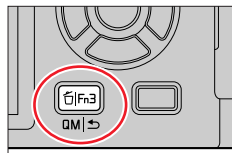

2 Use ▲ to select [Delete Single] and press [MENU/SET]

To delete multiple (up to 100*)/To delete all pictures

* A picture group is handled as 1 picture. (All the pictures in the selected picture group are deleted.)

1 Press [Fn] while viewing a picture

2 Use ▲▼ to select [Delete Multi]/[Delete All] and press [MENU/SET]

- You can select [Delete All Non-rating] in [Delete All] if there are pictures that have been set as [Rating].

(When [Delete Multi] is selected)

3 Use ▲▼◀▶ to select the pictures and press [MENU/SET] (repeat)

Ⓐ  Picture selected

- To cancel → Press [MENU/SET] again.

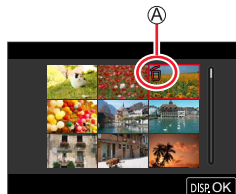

4 Press [DISP] to execute

- The time this takes depends on the number of pictures to be deleted.

Menu list

Menus to be displayed in each recording mode

[Snapshot Mode]

- [Snapshot Mode] (→51)
- [iHandheld Night Shot] (→53)
- [iHDR] (→54)

[Creative Video]

- [Exposure Mode] (→77)
- [High Speed Video] (→78)
- [4K Live Cropping] (→79)

[Custom Mode]

You can select your preferred custom setting group from [Set1], [Set2], and [Set3]. (→82)

[Panorama Shot]

- [Direction] (→65)
- [Picture Size] (→65)

[Scene Guide]

- [Scene Switch] (→67)

[Creative Control]

- [Filter Effect] (→71)
- [Simultaneous Record w/o Filter] (→71)

[Rec]	→165
-------	------

[Motion Picture]	→180
------------------	------

[Custom]	→182
----------	------

[Setup]	→196
---------	------

[My Menu]	→206
-----------	------

[Playback]	→207
------------	------

[Rec]

- The [AFS/AFF/AFC], [Sensitivity], [AF Mode], [Photo Style], [Filter Settings], [Metering Mode], [Highlight Shadow], [i.Dynamic], [i.Resolution], [Diffraction Compensation], [Stabilizer], [i.Zoom] and [Digital Zoom] menu items are common for both [Rec] and [Motion Picture] menus. If a setting in one menu is changed, the setting with the same name in other menu will also be changed automatically.
- [Aspect Ratio] (→166)
- [Picture Size] (→166)
- [Quality] (→167)
- [AFS/AFF/AFC] (→84)
- [Sensitivity] (→101)
- [AF Mode] (→85)
- [Photo Style] (→168)
- [Filter Settings] (→170)
- [Color Space] (→171)
- [Metering Mode] (→172)
- [Highlight Shadow] (→173)
- [i.Dynamic] (→174)
- [i.Resolution] (→174)
- [Flash] (→144)
- [Red-Eye Removal] (→174)
- [ISO Auto Upper Limit (Photo)] (→175)
- [Min. Shtr Speed] (→175)
- [Long Shtr NR] (→175)
- [Diffraction Compensation] (→176)
- [Stabilizer] (→137)
- [i.Zoom] (→140)
- [Digital Zoom] (→141)
- [Burst Rate] (→125)
- [4K PHOTO] (→108)
- [Self Timer] (→127)
- [Time Lapse Shot] (→131)
- [Stop Motion Animation] (→134)
- [Silent Mode] (→176)
- [Shutter Type] (→177)
- [Bracket] (→128)
- [HDR] (→178)
- [Multi Exp.] (→179)

[Aspect Ratio]

Recording modes: [A] [A] [P] [A] [S] [M] [M] [M] [SCN] [COL]

This function allows you to select the aspect ratio of the pictures to suit printing or the playback method.

MENU → **[Rec]** → **[Aspect Ratio]**

[4:3]	Aspect ratio of a 4:3 TV
[3:2]	Aspect ratio of standard 35mm film cameras
[16:9]	Aspect ratio of high-definition TV, etc.
[1:1]	Aspect ratio of a square image

[Picture Size]

Recording modes: [A] [A] [P] [A] [S] [M] [M] [M] [SCN] [COL]

The higher the resolution, i.e. the numbers of pixels, the finer the detail of the pictures will appear even when they are printed large.

MENU → **[Rec]** → **[Picture Size]**

[Aspect Ratio]	4:3	3:2	16:9	1:1
[Picture Size]	[L] 17.5M 4864×3648	[L] 20M 5472×3648	[L] 17M 5472×3080	[L] 13.5M 3648×3648
	[EX M] 9M 3456×2592	[EX M] 10M 3888×2592	[EX M] 8M 3840×2160	[EX M] 6.5M 2592×2592
	[EX S] 4.5M 2432×1824	[EX S] 5M 2736×1824	[EX S] 2M 1920×1080	[EX S] 3.5M 1824×1824

- The resolution will be fixed to [4K] when recording 4K photos or recording in [Post Focus].

Setting the file format/compression rate ([Quality])

Recording modes: **A** **A** **P** **A** **S** **M** **M** **SCN** **COL**

This function allows you to select the file format, e. g. JPEG and/or RAW, and in the case of JPEG, the compression rate. RAW is especially suited for the subsequent comprehensive editing of the image data using respective software, which is available after registering your camera on the Leica Camera AG homepage (→262). The JPEG setting [] delivers higher image quality than [] due to its lower compression rate, while the latter has the advantage of smaller files.

Set the compression rate used for storing pictures.

MENU → **[Rec]** → **[Quality]**

Settings	File format	Description
[]	JPEG	Gives priority to picture quality and saves pictures in JPEG file format.
[]		Saves pictures in JPEG file format using standard picture quality. This setting is useful when you want to increase the number of recordable pictures without changing the resolution.
[RAW] [RAW]	RAW + JPEG	Saves pictures in both RAW and JPEG file format ([] or []) simultaneously.
[RAW]	RAW	Saves pictures in RAW file format.



About the RAW file format

In RAW file format the data is saved without any picture processing by the camera. To play back and edit RAW file pictures, you must use this camera or dedicated software.









- You can develop the RAW file pictures using [RAW Processing] in the [Playback] menu. (→212)
- A RAW picture is always recorded at [3:2] (5472×3648).
 - If you delete a picture recorded in [RAW] or [RAW] from the camera, the corresponding RAW and JPEG pictures are also deleted.
 - When you play back a picture recorded with [RAW], the gray area is displayed according to the aspect ratio of the picture during recording.
 - The setting is fixed to [] when recording 4K photos or recording in [Post Focus].
 - You cannot set to [RAW], [RAW] or [RAW] in the following cases:
 - Panorama Shot Mode
 - [Handheld Night Shot] (Scene Mode)

[Photo Style]

Recording modes: **A** **A** **P** **A** **S** **M** **M** **SCN** COL

You can adjust the colors and picture quality according to the concept of the picture that you want to create.

MENU →  **[Rec]** → **[Photo Style]**

 STD. [Standard]	Standard setting.
 VIVID [Vivid]*	Setting with slightly high contrast and saturation.
 NAT [Natural]*	Setting with slightly low contrast.
 MONO [Monochrome]	Setting that creates a picture using monochrome shades of gray only, such as black and white.
 MONO HC [Monochrome HC]*	Setting that creates a monochrome picture using rich shades of gray with deep solid black tones.
 SCNY [Scenery]*	Setting that creates a picture using vivid colors for the blue sky and green.
 PORT [Portrait]*	Setting that produces the look of a healthy complexion.
 CUST [Custom]*	Setting for using colors and picture quality that were registered in advance.

* This setting is not available in Snapshot Plus Mode.

- In Snapshot Plus Mode, the setting will be reset to [Standard] when the camera is switched to another Recording mode or the camera is turned off and back on.
- Only picture quality adjustment can be set in the Scene Modes. (→169)

■ Adjusting the picture settings

- Picture settings are not available in the Snapshot Plus Mode.

- ① Press ◀▶ to select the type of Photo Style
- ② Press ▲▼ to select an item and press ◀▶ to adjust

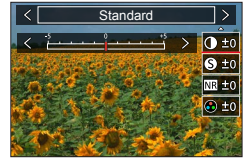

ⓘ [Contrast]	[+]	Increases the contrast in a picture.
	[-]	Decreases the contrast in a picture.
Ⓢ [Sharpness]	[+]	Enhances the outlines in a picture.
	[-]	Softens the outlines in a picture.
NR [Noise Reduction]	[+]	Increases the noise reduction effect to reduce noise. This setting may slightly lower the resolution.
	[-]	Lowers the noise reduction effect to achieve a picture quality with clearer resolution.
🌈 [Saturation]*1	[+]	Gaudy coloring
	[-]	Subdued coloring
🌈 [Color Tone]*1	[+]	Bluish coloring
	[-]	Yellowish coloring
🎛️ [Filter Effect]*2	[Yellow]	Enhances the contrast of a subject. (Effect: Low) Records a blue sky clearly.
	[Orange]	Enhances the contrast of a subject. (Effect: Medium) Records a blue sky with vibrant colors.
	[Red]	Enhances the contrast of a subject. (Effect: High) Records a blue sky with even more vibrant colors.
	[Green]	Applies subdued coloring for the skin and lips of a person. Emphasizes green leaves and makes them brighter.
	[Off]	—

*1 [Color Tone] is displayed only when [Monochrome] or [Monochrome HC] is selected. Otherwise, [Saturation] is displayed.

*2 Displayed only when [Monochrome] or [Monochrome HC] is selected.

- When picture settings are adjusted, [+] will be displayed in the [Photo Style] icon.

- ③ Press [MENU/SET]

■ Registering the setting for the adjusted picture settings to [Custom]

- ① Perform the picture settings adjustment in Step ② of “Adjusting the picture settings” and press [DISP]

[Filter Settings]

Recording modes: **A A P A S M M M** SCN COL

You can apply picture effects (filters) that are available for Creative Control Mode to images in other modes, such as Aperture-Priority Mode or Panorama Shot Mode. (→71)

MENU → **[Rec]** → **[Filter Settings]** → **[Filter Effect]**

Settings: **[ON]** / **[OFF]** / **[SET]**

■ With touch screen operations

- ① Touch
- ② Touch the item you want to set
 - : Picture effects ON or OFF
 - : Picture effects (Filter)
 - : Adjusting the picture effect



- [Rough Monochrome], [Silky Monochrome], [Soft Focus], [Star Filter] and [Sunshine] are not available in the following cases.
 - Creative Video Mode
 - During video recording
- The following functions are not available in Panorama Shot Mode.
 - [Toy Effect], [Toy Pop], [Miniature Effect], [Sunshine]
- When recording panorama pictures, the following effects are not applied to the recording screen.
 - [Rough Monochrome], [Silky Monochrome], [Soft Focus], [Star Filter]
- When recording a panorama picture in a scene with low brightness, you may not be able to achieve the desired results if [High Key] is used in the Panorama Shot Mode.
- The available ISO sensitivity settings will be limited up to [3200].
- The ISO sensitivity for [High Dynamic] will be fixed to [AUTO].
- When using [Filter Effect], you cannot use menus or recording functions which are not available in Creative Control Mode.
- This function is not available in the following cases:
 - When recording with [High Speed Video]
 - When recording using [4K Live Cropping]

■ Taking two pictures with and without picture effects ([Simultaneous Record w/o Filter])

You can take two pictures at the same time by pressing the shutter button once; one with effects and one without effects.

MENU → [Rec] → [Filter Settings] → [Simultaneous Record w/o Filter]

Settings: [ON] / [OFF]

- The camera will take a picture with the effects applied and then another one without the effects.
 - After taking the picture, [Auto Review] will display only the picture with the effects applied.
- This function is not available in the following cases:
 - Panorama Shot Mode
 - When using [Burst]
 - When recording 4K photos
 - When recording using [Post Focus]
 - When taking pictures while a video is being recorded
 - When [Quality] is set to [RAW], [RAW], or [RAW]
 - When recording using [Bracket]
 - When using [Time Lapse Shot]
 - When using [Stop Motion Animation]

[Color Space]

Recording modes: COL

You can set the method for reproducing the colors to correctly display the recorded pictures on the screens of a PC or printer, etc.

MENU → [Rec] → [Color Space]

[sRGB]	Sets the sRGB color space. This setting is widely used for devices such as PCs.
[AdobeRGB]	Sets the AdobeRGB color space. AdobeRGB color space has a wider color reproduction range than sRGB color space. Therefore, AdobeRGB color space is mainly used for business applications such as commercial printing.



- Select [sRGB] if you do not have expert knowledge about AdobeRGB color space.
- The setting is fixed to [sRGB] while recording video, recording 4K photos, or recording in [Post Focus].

[Metering Mode]

Recording modes: **A A P A S M M M SCN COL**

You can select between three different brightness metering methods.

MENU →  **[Rec]** → **[Metering Mode]**

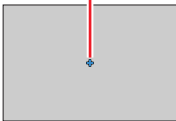
[Metering Mode]	Brightness measurement position	Conditions
 (Multiple)	The brightness is detected in different sections of the frame. The exposure is then based on the probable main subject	Normal usage (high probability of automatically correctly exposed main subjects even with greater brightness differences)
 (Center-weighted)	The metering sensitivity is concentrated on the center while also registering the rest of the frame	Use when the subject is in the center, or to deliberately base the exposure on an off-center subject (provided, subject is of medium brightness)
 (Spot)	Center of [+] (spot metering target) 	Use to base the exposure on very small subject parts (provided, these parts are of medium brightness)

- If you set the spot metering target on the edge of the screen, the metering may be affected by the brightness around the location.

[Highlight Shadow]

Recording modes: **A A P A S M M** SCN COL

You can adjust the highlights and shadows in a picture while confirming the brightness of these areas on the screen.

1 Set the menu

MENU → **[Rec]** → **[Highlight Shadow]**

<input type="checkbox"/> ([Standard])	No adjustments.
<input type="checkbox"/> ([Higher contrast])	Makes the highlighted areas brighter and shadowed areas darker.
<input type="checkbox"/> ([Lower contrast])	Makes the highlighted areas darker and shadowed areas brighter.
<input type="checkbox"/> ([Brighten shadows])	Makes the shadowed areas brighter.
<input type="checkbox"/> [C1] / [C2] / [C3] (Custom)	You can set a custom registration shape.

2 Rotate the control ring to adjust the brightness of the highlighted areas and rotate the thumb dial to adjust the brightness of the shadowed areas

- Ⓐ Highlighted area
- Ⓑ Shadowed area
- Ⓒ Preview display

- Adjustments can also be made by dragging the graph.
- To register your preferred settings, press ▲ to select the registration target icon (Custom 1, Custom 2, and Custom 3).

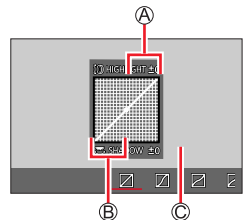

3 Press [MENU/SET]

- You can press [DISP] on the brightness adjustment screen to switch the screen display.



- The settings adjusted in , , , or will be restored to the default settings when the camera is turned off.

[i.Dynamic]

Recording modes: **[i.Dynamic]**

This function automatically adjusts contrast and exposure to give more lifelike colors when there is significant contrast between background and subject.

MENU → **[Rec]** → **[i.Dynamic]**

Settings: **[AUTO]** / **[HIGH]** / **[STANDARD]** / **[LOW]** / **[OFF]**

- You may not see the effect depending on the recording conditions.
- This function is not available in the following cases:
 - When **[HDR]** is set to **[ON]**
 - When **[Sensitivity]** is set to **[H.16000]**, **[H.20000]** or **[H.25000]**

[i.Resolution]

Recording modes: **[i.Resolution]**

You can use the camera's Intelligent Resolution technology to record pictures with sharper outlines and clearer resolution.

MENU → **[Rec]** → **[i.Resolution]**

Settings: **[HIGH]** / **[STANDARD]** / **[LOW]** / **[OFF]**

[Red-Eye Removal]

Recording modes: **[Red-Eye Removal]**

This function automatically detects red-eye and corrects picture data when recording with flash red-eye reduction (**[⚡⊗]** or **[+⚡⊗]**).

MENU → **[Rec]** → **[Red-Eye Removal]**

Settings: **[ON]** / **[OFF]**

- When this function is set to **[ON]**, the flash icon changes to **[⚡⊗]**/**[+⚡⊗]**.
- Depending on the circumstances, it may not be possible to correct red-eye.

[ISO Auto Upper Limit (Photo)]

Recording modes: **A A P A S M**   **COL**

You can set the upper limit of ISO sensitivity when ISO sensitivity is set to [AUTO] or [ISO].

MENU →  **[Rec]** → **[ISO Auto Upper Limit (Photo)]**

Settings: **[AUTO] / [200] / [400] / [800] / [1600] / [3200] / [6400] / [12500]**

- This function is not available in the following cases:
 - [Clear Nightscape], [Cool Night Sky], [Warm Glowing Nightscape], [Handheld Night Shot] (Scene Mode)

[Min. Shtr Speed]

Recording modes: **A A P A S M**   **COL**

You can set the minimum value for the shutter speed to be used when ISO sensitivity is set to [AUTO] or [ISO].

MENU →  **[Rec]** → **[Min. Shtr Speed]**

Settings: **[AUTO] / [1/16000] to [1/1]**

- The shutter speed may be slower than the setting value under recording conditions in which the correct exposure is not achieved.

[Long Shtr NR]

Recording modes: **A A P A S M**   **COL**

The camera can automatically eliminate the noise made when taking pictures with a slower shutter speed (e.g. to record night scenes).

MENU →  **[Rec]** → **[Long Shtr NR]**

Settings: **[ON] / [OFF]**

- While the camera eliminates the noise, [Long shutter noise reduction ongoing] is displayed for the same period as the shutter speed for the signal processing time.
- This function is not available in the following cases:
 - During video recording
 - When recording 4K photos
 - When recording using [Post Focus]
 - When using the electronic shutter

[Diffraction Compensation]

Recording modes: **A A P A S M M M SCN COL**

The camera enhances the resolution by correcting the blurriness caused by diffraction when the aperture is closed.

MENU →  **[Rec]** → **[Diffraction Compensation]**

Settings: **[AUTO] / [OFF]**

- Noise in the periphery of the picture may stand out with higher ISO sensitivity.

[Silent Mode]

Recording modes: **A A P A S M M M SCN COL**



This function allows disabling the beeps and flash at the same time.

MENU →  **[Rec]** → **[Silent Mode]**

Settings: **[ON] / [OFF]**

- This mode will mute beeps, set the flash to  (Forced Flash Off), and disable AF Assist Lamp.

The settings for the following functions are fixed:

- [Flash Mode]:  (Forced Flash Off)
- [Shutter Type]: [ESHTR]
- [AF Assist Lamp]: [OFF]
- [Beep Volume]:  (Off)
- [Shutter Vol.]:  (Off)

- Even when this mode is set to [ON], the following lamps/indicators will light or flash.
 - Self-timer indicator
 - WIRELESS connection lamp
- The operation sounds of this camera such as the lens aperture sound are not muted.

[Shutter Type]

Recording modes: **A** **P** **A** **S** **M** **SCN** **COL**

You can take pictures using two types of shutter modes: the mechanical shutter and electronic shutter.

	Mechanical shutter	Electronic shutter
Flash	○	—
Shutter Speed (seconds)	T (Time)*1, 60 - 1/2000	1 - 1/16000
Shutter sound	Mechanical shutter sound + Electronic shutter sound*2	Electronic shutter sound*2

*1 This setting is available only in Manual Exposure Mode.

*2 You can use [Shutter Vol.] and [Shutter Tone] to adjust the volume of the electronic shutter sound. (→198)

MENU → **[Rec]** → **[Shutter Type]**

[AUTO]	The shutter mode automatically switches based on the recording conditions and shutter speed. • The mechanical shutter mode has higher priority over the electronic shutter mode because the mechanical shutter has less function-related restrictions when recording with a flash, etc.
[MSHTR]	Uses only the mechanical shutter mode to take a picture.
[ESHTR]	Uses only the electronic shutter mode to take a picture.

- When [E] is displayed on the screen, recording is performed with an electronic shutter.
- If you take a picture of a moving subject using the electronic shutter, the subject in the picture may be skewed in some cases.
- When you take a picture under a fluorescent or LED lighting fixture using the electronic shutter, the recorded picture may have horizontal stripes. If you use a slower shutter speed, the horizontal stripes may be reduced.

[HDR]

Recording modes:   SCN COL

The camera can combine 3 pictures taken at different exposures into a single picture with a wide range of correctly rendered brightness levels. The individual pictures used to create the HDR picture are not saved.





A combined HDR picture is saved in JPEG format.

MENU →  **[Rec]** → **[HDR]**

Settings: **[ON]** / **[OFF]** / **[SET]**

■ Changing the settings

[Dynamic Range]	<p>[AUTO]: Takes pictures after automatically setting the adjustment range of the exposure based on the contrast of a subject.</p> <p>[±1EV] / [±2EV] / [±3EV]: Takes pictures using the adjustment range of the exposure being set.</p>
[Auto Align]	<p>[ON]: Automatically adjusts the displacement of pictures caused by camera shake, etc. We recommend using this setting to take pictures with a handheld camera.</p> <p>[OFF]: Does not adjust the displacement of pictures. We recommend using this setting when you use a tripod.</p>

- After the shutter button has been pressed, do not move the camera during the exposure series.
- Since a series of pictures are combined after they have been recorded, it will take a few moments before you will be able to record another picture.
- A subject that was in motion when it was recorded may be recorded as an afterimage.
- When [Auto Align] is set to [ON], the captured area is slightly smaller.
- When you take pictures using the flash, the flash mode is fixed to  (Forced Flash Off).
- This function will not work for pictures while videos are being recorded.
- This function is not available in the following cases:
 - When using [Burst]
 - When recording 4K photos
 - When recording using [Post Focus]
 - When recording using [Bracket]
 - When [Quality] is set to , , or 
 - When using [Time Lapse Shot]
 - When [Auto Shooting] of [Stop Motion Animation] is set to [ON]

[Multi Exp.]

Recording modes: **A A P A S M** ▶ M □ SCN COL

You can create an effect similar to combining up to four exposures in a single picture.

MENU →  **[Rec]** → **[Multi Exp.]**

1 Press ▲ to select [Start] and then [MENU/SET]**2 Decide on your composition and take the first picture**

- After recording the first picture, press the shutter button halfway to proceed to the next recording.
- Press ▲▼ to select the item and then [MENU/SET]. You can perform the following operations.
 - [Next]: Proceed to the next recording.
 - [Retake]: Delete the result of the last shot and take another picture.
 - [Exit]: Exit Multi Exposure and save the picture that was taken.

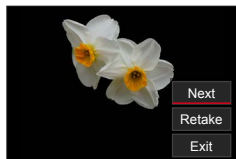
**3 Record the second, third, and fourth pictures**

- When you press [Fn3] while taking pictures, the pictures that you took are saved and Multi Exposure is closed.

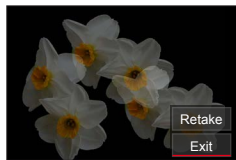
**4 Press ▼ to select [Exit] and then [MENU/SET]**

- You can also end the operation by pressing the shutter button halfway.

■ Changing the settings

[Auto Gain]	If you select [OFF], all exposure results are superimposed as they are. Compensate the exposure as necessary, depending on the subject.
[Overlay]	If you select [ON], you can apply Multi Exposure to previously recorded pictures. After [Start] is selected, pictures on the card will be displayed. Select a RAW image, and press [MENU/SET] to proceed to recording.

- When you take the second and subsequent pictures, you cannot change the focal length, i.e. zoom.
- Information for the picture taken last will be used as recording information of pictures taken using Multi Exposure.
- You can perform [Overlay] on RAW file pictures recorded using this camera only.
- This function is not available in the following cases:
 - When using [Time Lapse Shot]
 - When using [Stop Motion Animation]

[Motion Picture]

- The [AFS/AFF/AFC], [Sensitivity], [AF Mode], [Photo Style], [Filter Settings], [Metering Mode], [Highlight Shadow], [i.Dynamic], [i.Resolution], [Diffraction Compensation], [Stabilizer], [i.Zoom] and [Digital Zoom] menu items are common for both [Rec] and [Motion Picture] menus. If a setting in one menu is changed, the setting with the same name in other menu will also be changed automatically. For details, refer to the corresponding item of the [Rec] menu.
- [Rec Quality] (→150)
- [Snap Movie] (→153)
- [Continuous AF] (→151)
- [ISO Auto Upper Limit (Video)] (→78)
- [Flkr Decrease] (→180)
- [Level Shot] (→180)
- [Wind Noise Canceller] (→181)
- [Zoom Mic] (→181)

[Flkr Decrease]

Recording modes:  SCN COL

The shutter speed can be fixed to reduce the flicker or striping in a video.

MENU →  [Motion Picture] → [Flkr Decrease]

Settings: [1/50] / [1/60] / [1/100] / [1/120] / [OFF]

[Level Shot]

Recording modes:  SCN COL

The Level Shot function automatically detects the camera's tilt while recording videos, and horizontally corrects the recording video so it will not be tilted.

MENU →  [Motion Picture] → [Level Shot]

Settings: [ON] / [OFF]

- If you record while walking, or if the camera's tilt is large, it may not be possible to horizontally correct the video.
- The captured area is slightly smaller when video recording starts.
- Pictures taken while recording videos will not be horizontally corrected.
- This function is not available in the following cases:
 - When recording with [High Speed Video]
 - When recording using [4K Live Cropping]
 - When [Stabilizer] is set to [OFF]
 - When [Rec Quality] is set to [4K/100M/30p] or [4K/100M/24p]

[Wind Noise Canceller]

Recording modes: **P** **A** **S** **M** **COL**

This will reduce the wind noise coming into the built-in microphones while maintaining sound quality.

MENU → **[Motion Picture]** → **[Wind Noise Canceller]**

Settings: **[HIGH]** / **[STANDARD]** / **[OFF]**

- **[HIGH]** effectively reduces the wind noise by minimizing the low-pitched sound when a strong wind is detected.
 - **[STANDARD]** extracts and reduces only the wind noise without deteriorating the sound quality.
- You may not experience the full effect depending on the recording conditions.

[Zoom Mic]

Recording modes: **P** **A** **S** **M** **COL**

Coupled to the zoom operation, it will more clearly record sounds from more distant sources when using longer focal lengths, and surrounding sounds with shorter focal lengths.

MENU → **[Motion Picture]** → **[Zoom Mic]**

Settings: **[ON]** / **[OFF]**

- When set to **[ON]** and zooming, the operation sound may also be more obvious in accordance with the surrounding sounds. Also, the audio recording level will be lower compared to when **[OFF]**.
- The stereo effect of the audio is reduced when using longer focal lengths.

[Custom]** [Exposure]**

- [ISO Increments] (→183)
- [Extended ISO] (→183)
- [Exposure Comp. Reset] (→183)

 [Focus / Release Shutter]

- [AF/AE Lock] (→99)
- [AF/AE Lock Hold] (→183)
- [Shutter AF] (→183)
- [Half Press Release] (→183)
- [Quick AF] (→183)
- [Eye Sensor AF] (→184)
- [Pinpoint AF Setting] (→184)
- [AF Assist Lamp] (→184)
- [Direct Focus Area] (→184)
- [Focus/Release Priority] (→185)
- [Focus Switching for Vert / Hor] (→185)
- [Loop Movement Focus Frame] (→185)
- [AF Area Display] (→185)
- [AF+MF] (→186)
- [MF Assist] (→186)
- [MF Assist Display] (→186)

 [Operation]

- [Fn Button Set] (→46)
- [Q.MENU] (→45)
- [Ring/Dial Set] (→49)
- [Operation Lock Setting] (→186)
- [Touch Settings] (→186)
- [Dial Guide] (→187)
- [Zoom lever] (→187)

 [Monitor / Display]

- [Auto Review] (→187)
- [Monochrome Live View] (→188)
- [Constant Preview] (→188)
- [Peaking] (→188)
- [Histogram] (→189)
- [Guide Line] (→189)
- [Center Marker] (→189)
- [Highlight] (→190)
- [Zebra Pattern] (→190)
- [Expo.Meter] (→191)
- [MF Guide] (→191)
- [EVF/Monitor Disp. Set] (→36)
- [Rec Area] (→191)
- [Remaining Disp.] (→191)
- [Menu Guide] (→191)

 [Lens / Others]

- [Lens Position Resume] (→192)
- [Lens Retraction] (→192)
- [Self Timer Auto Off] (→192)
- [Face Recog.] (→192)
- [Profile Setup] (→195)

MENU →  [Custom] →  [Exposure]

[ISO Increments]

You can change the setting to increase ISO sensitivity by 1 EV or 1/3 EV.

[Extended ISO]

You can extend the numeric values that can be set for ISO Sensitivity. (→101)

[Exposure Comp. Reset]

If the recording mode is changed or the camera is turned off, the exposure compensation value setting is reset.

MENU →  [Custom] →  [Focus / Release Shutter]

[AF/AE Lock Hold]

Focus and exposure stay locked even if you press and release [AE|AF LOCK] (or the function button where [AF/AE LOCK] is registered). Press the button again to cancel the lock.

[Shutter AF]

Sets whether or not the focus is adjusted automatically when the shutter button is pressed halfway.

[Half Press Release]

This function trips the shutter immediately when the shutter button is pressed halfway.

[Quick AF]

With this setting, the focus setting is automatically adjusted when camera blurring is small even when the shutter button is not pressed. (Increases battery consumption.)

- This function is not available in the following cases:
 - Preview Mode
 - When the lighting is low

MENU →  **[Custom]** →  **[Focus / Release Shutter]**

[Eye Sensor AF]

Adjusts the focus automatically when the eye sensor is activated.

- [Eye Sensor AF] may not work when the lighting is low.

[Pinpoint AF Setting]

[Pinpoint AF Time]	Sets the time for which the screen is enlarged when the shutter button is pressed halfway with Autofocus Mode set to [+] .
[Pinpoint AF Display]	Sets whether to display the enlarged screen that appears when Autofocus Mode is set to [+] in a window or full screen.







[AF Assist Lamp]

Illuminates the AF Assist Lamp when the shutter button is pressed halfway when it is too dark to facilitate focusing.

- The AF Assist Lamp has an effective range of approx. 1.5 m (5').
- The setting is fixed to [OFF] in the following cases:
 - [Distinct Scenery], [Bright Blue Sky], [Romantic Sunset Glow], [Vivid Sunset Glow], [Glistening Water], [Clear Nightscape], [Cool Night Sky], [Warm Glowing Nightscape], [Artistic Nightscape], [Handheld Night Shot] (Scene Mode)
 - When [Silent Mode] is set to [ON]

[Direct Focus Area]

Moves the AF area or MF assist using the cursor buttons while recording.

- When , , , or  is selected, you can move the AF area, when  is selected, you can move the lock start position, and when  is selected, you can move the focus position.
- Perform the setting of functions assigned to the cursor buttons using the Quick menu (→44) or function buttons (→46).
- [Direct Focus Area] is fixed to [OFF] in the following cases:
 - [Glistening Water] (Scene Mode)
 - Creative Control Mode
 - When recording using [4K Live Cropping]

MENU →  **[Custom]** →  **[Focus / Release Shutter]**

[Focus/Release Priority]

You can set whether to give higher priority to focusing or shutter release timing when you take pictures using Autofocus mode.

You can set the priority for each focus mode ([AFS/AFF], [AFC]) separately.

[FOCUS]	No picture is taken unless focusing is achieved.
[BALANCE]	A picture is taken with an appropriate balance between focusing and shutter release timing.
[RELEASE]	A picture is taken even if the subject is out of focus.

[Focus Switching for Vert / Hor]

The camera saves the focus positions of a picture separately when it is recorded by holding the camera vertically and horizontally. The camera saves the following positions of the picture taken the previous time.





- AF area position (When , , and  are set)
- Position displayed by MF Assist

[Loop Movement Focus Frame]

You can move a focus area from one edge to the opposite edge of the screen in a loop when the AF area position or MF Assist area display position is set.

[AF Area Display]

You can perform the AF area display setting when the Autofocus Mode is set to  (49-area-focusing) or Custom Multi.

[ON]	Displays the AF area on the recording screen. <ul style="list-style-type: none"> • When the default AF area is selected in  (49-area-focusing) or , , or  of Custom Multi-function, the AF area is not displayed.
[OFF]	Displays the AF area on the recording screen for only a few seconds after the AF area is set.

- The [ON] setting operates as [OFF] in the following cases.
 - When recording videos
 - Creative Video Mode
 - When recording 4K photos

MENU →  **[Custom]** →  **[Focus / Release Shutter]**

[AF+MF]

You can manually perform fine focusing during AF Lock (pressing the shutter button halfway when [AFS/AFF/AFC] in [Rec] menu is set to [AFS] or setting AF Lock by pressing [AF/AE LOCK]).

[MF Assist]

Allows you to set whether or not to display the MF Assist (enlarged screen) during Manual Focus.

- MF Assist is not displayed in the following cases:
 - During video recording
 - When recording with  ([4K Pre-Burst]) of the 4K Photo function
 - When using the Digital Zoom

[MF Assist Display]

Allows you to set whether or not to display the MF Assist (enlarged screen) in a window or full screen.

MENU →  **[Custom]** →  **[Operation]**

[Operation Lock Setting]

You can set an object for which operation is disabled when [Operation Lock] is assigned to the function button using [Fn Button Set] (→46) in the [Custom] ([Operation]) menu.

[Cursor]	Disables the operation of the cursor buttons and [MENU/SET] button.
[Touch Screen]	Disables the touch operation using the touch panel.

[Touch Settings]

Enabling/disabling the touch operation.

[Touch Screen]	All touch operations.
[Touch Tab]	Operations of tabs, such as  displayed on the right side of the screen.
[Touch AF]	Operation to optimize the focus [AF] or both the focus and brightness [AF+AE] for a touched subject.
[Touch Pad AF]	Operation to move the AF area by touching the monitor when the viewfinder is in use. (→94)

MENU →  [Custom] →  [Operation]

[Dial Guide]

Enabling/disabling the operation guide display when switching recording modes.





Example

[Zoom lever]

Changing the zoom operation settings.

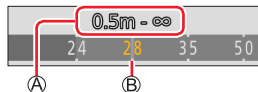
Q (Zoom)	Zooming operates in the normal way.
Q (Step Zoom)	<p>Each time the lever is operated, the zoom lens stops at the position for one of the preset focal lengths.</p> <p>Ⓐ Focusing range Ⓑ Current zoom position</p> <ul style="list-style-type: none"> This setting does not work when recording videos or 4K photos with  ([4K Pre-Burst]).





MENU →  [Custom] →  [Monitor / Display]

[Auto Review]

[Duration Time (photo)]	Sets the time to display the pictures you have taken after taking them.
[Duration Time (4K PHOTO)]	Sets the time to display the pictures you have taken after recording 4K photos.
[Duration Time (Post Focus)]	Sets the time to display the pictures you have taken after recording using [Post Focus].
[Playback Operation Priority]	Allows you to switch the playback screen or to delete pictures when the [Auto Review] function is activated.

- When [Duration Time (photo)] is set to [HOLD], pictures are displayed until you press the shutter button halfway. In this case, [Playback Operation Priority] is fixed to [ON].

MENU →  [Custom] →  [Monitor / Display]

[Monochrome Live View]

You can display the recording screen in black and white. This function is useful when this would make it easier to focus in Manual Focus mode.

- When using the HDMI output during recording, the image is not displayed in black and white.
- This does not affect recorded pictures.

[Constant Preview]

You can check the effects of the chosen aperture and shutter speed on the recording screen in Manual Exposure Mode.





- This function is disabled when the flash is used.



[Peaking]

When you perform Manual Focus operation, this function automatically colors the edges of the subject parts that are in Focus.

- When [Detect Level] in [SET] is set to [HIGH], the indication is more discriminate, allowing you to achieve a more precise focus.
- Changing the [Detect Level] setting also changes the [Display Color] setting as follows.

[Detect Level]	[HIGH]	↔	[LOW]
[Display Color]	 (Light blue)	↔	 (Blue)
	 (Yellow)	↔	 (Orange)
	 (Yellow Green)	↔	 (Green)
	 (Pink)	↔	 (Red)
	 (White)	↔	 (Gray)

- Each time  in  is touched, the setting is switched in order of  ([Detect Level]: [LOW]) →  ([Detect Level]: [HIGH]) → [OFF].
- This function is not available in the following case:
 - [Rough Monochrome] (Creative Control Mode)

MENU →  **[Custom]** →  **[Monitor / Display]**

[Histogram]

Enables/disables the histogram display.

When set to [ON], you can move the display position of the histogram by pressing ▲▼◀▶.

- Direct touch operation is also possible on the recording screen.

The histogram displays distribution of brightness in picture – e.g. if the graph peaks at the right, this means the picture is probably overexposed. A peak in the center represents correct brightness (correct exposure). This can be used as a reference for exposure correction, etc.

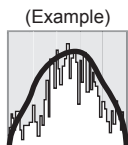



Dark ← OK → Bright

- **When the histogram is not the same as that of the recorded picture under the following conditions, it will be displayed in orange:**

- During Exposure Compensation.
- When the flash fires.
- When the correct exposure is not achieved, such as when the lighting is low.



[Guide Line]

This function allows selecting the pattern of the guidelines to be displayed while recording.

- When you select , you can move the position of the guideline by pressing ▲▼◀▶.
- You can also set the position directly by touching  on the guideline of the recording screen.
- The guideline is not displayed during panorama picture recording.

[Center Marker]

A cross [+] is displayed to indicate the center of the recording screen. This is useful for zooming while keeping the subject at the center of the screen.

MENU →  **[Custom]** →  **[Monitor / Display]**

[Highlight]

You can set overexposed areas (areas that are too bright and where there are no shades of gray) to flash on the screen when the [Auto Review] function is activated or during playback.

- To reduce overexposed areas, record a picture by setting negative exposure compensation using the histogram display and so on as a reference.
- This feature is disabled during 4K photo playback, playback of pictures recorded in [Post Focus], Multi Playback, Calendar Playback, or Playback Zoom.
- This does not affect recorded pictures.



[Zebra Pattern]

You can check the area in a picture, which could result in overexposure, by displaying such an area using a zebra pattern.

[ZEBRA1]:

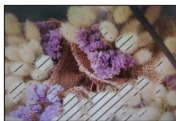



[ZEBRA2]:



Select [SET] to set the brightness to be displayed for each zebra pattern.

- The range of brightness you can select from is [50%] to [105%]. The [OFF] setting is available for [Zebra 2]. When [100%] or [105%] is selected, only the overexposed areas are displayed with the zebra pattern. When a smaller numeric value is set, the range of brightness to be displayed by each zebra pattern will increase.

- To reduce overexposed areas, record a picture by setting negative exposure compensation using the histogram display and so on as a reference.
- The displayed zebra pattern is not recorded.
- When [Zebra Pattern] is assigned to the function button using [Fn Button Set] (→46) in the [Custom] ([Operation]) menu, every time you press the assigned function button, the setting will switch in the following order: [Zebra 1] → [Zebra 2] → [Zebra OFF]. When [Zebra 2] is set to [OFF], you can switch the setting quickly in the following order: [Zebra 1] → [Zebra OFF].

MENU →  [Custom] →  [Monitor / Display]

[Expo.Meter]

This function enables/disables the exposure meter display.

 Exposure meter

- When you set this function to [ON], an exposure meter is displayed during Program Shift, aperture setting, and shutter speed setting.
- Proper exposure is not possible in the range indicated in red.
- If the exposure meter is not displayed, press [DISP] to switch the display of the monitor.
- The exposure meter will turn off if no operation is performed for approximately 4 seconds.

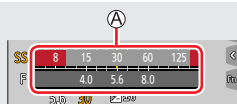

[MF Guide]



When you focus manually, the MF guide is displayed on the screen. You can check where the lens is presently focused.

 Indicator for ∞ (infinity)



[Rec Area]

Switches the captured area setting used for recording pictures and videos.

	Indicated as the captured area when recording pictures.
	Indicated as the captured area when recording videos.



- The recording area indicated is an approximation.
- [Rec Area] is fixed to  when recording 4K photos or recording in [Post Focus].

[Remaining Disp.]

Switches the display between the number of recordable pictures that you can take and the available recording time.

[Menu Guide]

Switches between displaying/not displaying the selection screen when the mode dial is switched to [SCN]/[COL].

MENU →  **[Custom]** →  **[Lens / Others]**

[Lens Position Resume]

Remembers the zoom and focus positions when the camera is turned off.

[Lens Retraction]

Sets whether or not to retract the lens barrel shortly after the playback screen appears.

[Self Timer Auto Off]

Switches whether or not the self-timer is canceled when the camera is turned off.

[Face Recog.]

The Face Recognition function recognizes a face similar to a registered face and automatically adjusts focus and exposure for the face with higher priority. Even if a person you want to focus on is standing at the back or corner in a group photo, the camera will automatically recognize the person and record this person's face clearly.

Settings: [ON] / [OFF] / [MEMORY]

■ How the Face Recognition function works



During recording

- The camera recognizes a registered face and adjusts focus and exposure.
- When registered faces that have set names are recognized, the names are displayed (max. 3 people).

During playback

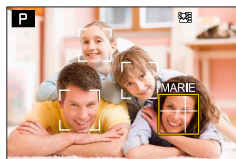
- The name and age are displayed.





MENU →  [Custom] →  [Lens / Others]

■ Registering face pictures

Up to 6 people's faces can be registered along with such information as name and birthdate.

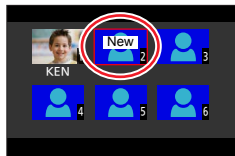
- ① Use ▼ to select [MEMORY] and press [MENU/SET]
- ② Use ▲▼◀▶ to select [New] and press [MENU/SET]



- ③ Target the face within the frame and record
 - Faces of subjects other than people (e.g. pets) cannot be registered.
 - When ► is pressed or  is touched, an explanation is displayed.

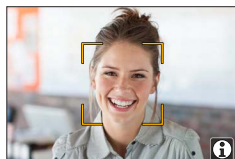



- ④ Use ▲▼ to select the item for editing and press [MENU/SET]

[Name]	Sets the name. • For details on how to enter characters, refer to "Entering Text" (→50)
[Age]	Sets the birthdate.
[Add Images]	Up to 3 face pictures of the person can be registered. ① Use ◀▶ to select [Add] and press [MENU/SET] • When a registered face picture is selected with cursor buttons, a screen to confirm deletion is displayed. Select [Yes] to delete the face picture. ② Record the picture (step ③)

■ Editing or deleting information about registered persons

- ① Use ▼ to select [MEMORY] and press [MENU/SET]
- ② Use ▲▼◀▶ to select the picture of the person to be edited or deleted and press [MENU/SET]
- ③ Use ▲▼ to select the item and press [MENU/SET]

[Info Edit]	Allows editing name or other registered information. (Step ④ of "Registering face pictures")
[Priority]	For setting the priority order for focus and exposure. ① Use ▲▼◀▶ to select the registration order and press [MENU/SET]
[Delete]	For deleting information and face pictures of registered persons.

MENU →  **[Custom]** →  **[Lens / Others]**

Recording tips when registering face pictures

- Make sure the subject's eyes are open and mouth closed; have the subject face the camera directly, and make sure the outline of the face, the eyes and eyebrows are not hidden by hair.
- Make sure there are no heavy shadows on the face. (During registration, the flash is not used.)



Good example for registering a face



If the camera seems to have difficulty recognizing faces when recording

- Register additional pictures of the same person's face, indoors and outdoors or with different expressions or angles.
- Register additional pictures at the place you are recording.
- If a registered person is no longer recognized, re-register that person.
- In some cases, the camera cannot recognize or incorrectly recognizes even registered people depending on their expression or the environment.

- **[Face Recog.] functions only when Autofocus mode is set to .**
- Only the first picture of a serial recording will contain Face Recognition information.
- The name of the person recognized in the first picture is displayed in the case of group pictures.
- This function is not available in the following cases:
 - [Miniature Effect] (Creative Control Mode)
 - During video recording
 - When recording 4K photos
 - When recording using [Post Focus]
 - When using [Time Lapse Shot]

MENU →  **[Custom]** →  **[Lens / Others]**

[Profile Setup]

Allows you to set a name or birthday of a baby or pet before taking a picture to record the name or age in months/years in the picture.

Settings:  **1** ([Baby1]) /  **2** ([Baby2]) /  ([Pet]) / [OFF] / [SET]

■ Setting the name and age in months/years

- ① Use ▼ to select [SET] and press [MENU/SET]
- ② Use ▲▼ to select [Baby1], [Baby2] or [Pet] and press [MENU/SET]
- ③ Use ▲▼ to select [Age] or [Name] and press [MENU/SET]
- ④ Use ▼ to select [SET] and press [MENU/SET]
 - Enter the [Age].
 - Enter the [Name].
 - For details on how to enter characters, refer to “Entering Text” (→50)

■ Canceling the display of the name and age in months/years

Set [Profile Setup] to [OFF].

- [Profile Setup] is not available for 4K photo recording or recording in [Post Focus].
- You cannot record the name or age in months/years in the following cases:
 - During video recording
 - Pictures that are taken while recording videos

[Setup]

MENU →  [Setup]

- [Cust.Set Mem.] (→81)
- [Clock Set] (→28)
- [World Time] (→196)
- [Travel Date] (→197)
- [Wi-Fi] (→197)
- [Bluetooth] (→198)
- [Wireless Connection Lamp] (→198)
- [Beep] (→198)
- [Economy] (→199)
- [Monitor Display Speed] (→200)
- [EVF Display Speed] (→200)
- [Monitor Display] / [Viewfinder] (→200)
- [Monitor Luminance] (→201)
- [m/ft] (→201)
- [Eye Sensor] (→201)
- [USB Mode] (→201)
- [TV Connection] (→202)
- [Language] (→203)
- [Version Disp.] (→203)
- [Folder / File Settings] (→203)
- [No.Reset] (→205)
- [Reset] (→205)
- [Reset Network Settings] (→205)
- [Level Gauge Adjust.] (→206)
- [Format] (→26)

[World Time]

Sets the times for the region where you live and your travel destination.

- You can set [Destination] after setting [Home].

Settings: [Destination] / [Home]

1 Use ▲ ▼ to select [Destination] or [Home] and press [MENU/SET]

2 Use ◀ ▶ to select area and press [MENU/SET]



When [Destination] has been selected



When [Home] has been selected

- Ⓐ Current time at selected destination
- Ⓑ City/area name
- Ⓒ Difference with home time



■ To set daylight savings

Press ▲ in step **2**. (Press again to release the setting)

- When daylight savings [☀️] is set, the current time is advanced by 1 hour. If the setting is canceled, the time automatically returns to the current time.

■ When you come back from your travel destination

Select [Home] in step **1** and press [MENU/SET].

- If you cannot find your destination in the area displayed on the screen, set it based on difference with home time.

[Travel Date]

■ [Travel Setup]

If you set your travel schedule and record pictures, the day of your trip on which the picture was taken will be recorded.

■ To record [Location]

Once the [Travel Setup] is set, you can set the location.

- For details on how to enter characters, refer to “Entering Text” (→50)
- To print [Location] or the number of days that have passed, use [Text Stamp].
- The travel date is calculated from the set departure date and the date set in the camera's clock. When destination is set in [World Time], days elapsed are calculated based on local destination time.
- When [Travel Setup] is set to [OFF], the number of days elapsed is not recorded. It is not displayed even if [Travel Setup] is set to [SET] after recording.
- When the current date passes the return date, [Travel Setup] is automatically canceled.
- [Location] cannot be recorded while recording videos, recording 4K photos, or recording in [Post Focus].

[Wi-Fi]

■ [Wi-Fi Function] (→249)

■ [Wi-Fi Setup] (→255)



[Bluetooth]

- [Bluetooth] (→228)
- [Remote Wakeup] (→235)
- [Returning from Sleep Mode] (→239)
- [Auto Transfer] (→241)
- [Location Logging] (→243)
- [Auto Clock Set] (→244)
- [Wi-Fi network settings]

Registers a wireless access point. (→249)

- The wireless access point used for the Wi-Fi connection is automatically registered.
- Up to 17 wireless access points can be registered. If you try to register more than 17 access points, the oldest registered access point will be deleted.
- Performing [Reset Network Settings] will delete registered wireless access points.

[Wireless Connection Lamp]

The lamp lights up while the wireless function is operating.

Settings: [ON] / [OFF]

[Beep]

Sets the beep sounds or shutter sounds.

- [Beep Volume]
- [Shutter Vol.]
- [Shutter Tone]

- When [Silent Mode] is set to [ON], [Beep] is not available.



[Economy]

■ [Sleep Mode]

The camera is automatically turned off if it has not been used for the time selected on the setting.

- When you want to use the camera again, either press the shutter button halfway or turn it back on.

■ [Sleep Mode(Wi-Fi)]

The camera is automatically turned off if it has not been used for approx. 15 minutes with no Wi-Fi connection.

- When you want to use the camera again, either press the shutter button halfway or turn it back on.

■ [Auto EVF/Monitor Off]

The monitor/viewfinder is automatically turned off if the camera has not been used for the time selected on the setting.

- To turn the monitor/viewfinder on again, press any button.

● This function is not available in the following cases:

- During video recording/playback
- When recording with [4K Pre-Burst] ([4K Pre-Burst]) of the 4K Photo function
- When recording in [Multi Exp.]
- When connected to computer/printer
- During Slide Shows
- When using [Time Lapse Shot]
- When [Auto Shooting] of [Stop Motion Animation] is set to [ON]
- While the HDMI output is being used for recording.



[Monitor Display Speed] / [EVF Display Speed]

Allows setting the display speed of the monitor or viewfinder.

[ECO 30fps]	Minimizes power consumption and the operating time is extended.
[60fps]	You can display a moving subject in fluid motion. This setting is ideal for recording fast-moving subjects.

- When [Monitor Display Speed] or [EVF Display Speed] (or both) is set to [ECO 30fps], Digital Zoom is not available.
- [ECO 30fps] cannot be set in the following cases:
 - Creative Video Mode
 - When recording 4K photos
 - When recording using [Post Focus]
- [Monitor Display Speed] and [EVF Display Speed] are disabled while the HDMI output is being used for recording.
- The [Monitor Display Speed]/[EVF Display Speed] setting does not affect the recorded picture.

[Monitor Display] / [Viewfinder]

Allows adjusting brightness and color of the monitor or viewfinder.

[Brightness]	Adjusts the brightness.
[Contrast]	Adjusts the contrast.
[Saturation]	Adjusts the vividness of colors.
[Red Tint]	Adjusts red hues.
[Blue Tint]	Adjusts blue hues.

- It will adjust the monitor when the monitor is in use, and the viewfinder when the viewfinder is in use.
- Some subjects may look different from their actual appearance, but the recorded picture will not be affected.



[Monitor Luminance]

Allows setting the monitor brightness according to the ambient light level.

(Auto)	The brightness is adjusted automatically depending on how bright it is around the camera.
(Mode 1)	The brightness is increased.
(Mode 2)	The brightness is standard.
(Mode 3)	The brightness is decreased.

- Some subjects may look different from their actual appearance, but the recorded picture will not be affected.
- [] returns to ordinary brightness if there is no operation for 30 seconds when recording. (Press any button or touch the screen to make the screen brighter again.)
- Setting [] or [] reduces the operating time.
- Cannot select [] during playback.

[m/ft]

Allows selecting how distance is displayed, in Ft or M.

[Eye Sensor]

[Sensitivity]	Use this setting to set the sensitivity of the eye sensor.
[EVF/Monitor Switch]	Use this setting to switch the display between the viewfinder and monitor. [EVF/MON AUTO] (Automatic switching between viewfinder and monitor) / [EVF] (Viewfinder display) / [MON] (Monitor display) • After the display is switched using the [EVF] button, the setting of [EVF/Monitor Switch] will also change.

[USB Mode]

Allows selecting the communication method for when connecting camera to a computer or printer with USB cable.

[Select on connection]	Selects the communication method each time you connect to a computer or PictBridge-compatible printer.
[PC(Storage)]	Selects when connecting to a computer.
[PictBridge(PTP)]	Selects when connecting to a PictBridge-compatible printer.



[TV Connection]

■ [HDMI Mode (Play)]

Set the format for the output.

[AUTO]	Automatically sets the output resolution based on information from a connected TV.
[4K/30p]	Outputs pictures with a resolution of 3840×2160 pixels using progressive scan for 2160 effective scanning lines.
[1080p]	Outputs pictures using progressive scan for 1080 effective scanning lines.
[1080i]	Outputs pictures using interlace scan for 1080 effective scanning lines.
[720p]	Outputs pictures using progressive scan for 720 effective scanning lines.
[480p]	Outputs pictures using progressive scan for 480 effective scanning lines.

- If no image appears on the TV with [AUTO], switch the setting to one supported by your TV. (Please read the instructions for the TV.)

■ [HDMI Info Display (Rec)]

Set whether to display recording information when you take pictures while you monitor them on a TV or other device by connecting the camera via HDMI micro cable. (→260)

■ [HDTV Link]

If you select [ON], operations of the camera and the HDTV Link compatible equipment connected to the camera with an HDMI micro cable are automatically linked, enabling you to control the camera with the remote control of the HDTV Link compatible equipment. (→261)



[Language]

Allows setting the language displayed on the screen.

- If you set a different language by mistake, select [00] from the menu icons to set the desired language.

[Version Disp.]

Allows checking the firmware version of the camera.

- When you press [MENU/SET] while the version is displayed, software information for this camera, such as the license, is displayed.

[Folder / File Settings]

Allows setting the names of a folder and file for storing images.

Folder name	File name
<p style="text-align: center;">100ABCDE</p> <div style="display: flex; justify-content: center; gap: 20px;"> ① ② </div> <ul style="list-style-type: none"> ① Folder number (3-digits, 100–999) ② User-defined 5-digit number 	<p style="text-align: center;">LABC0001.JPG</p> <div style="display: flex; justify-content: center; gap: 10px;"> ① ② ③ ④ </div> <ul style="list-style-type: none"> ① Color space ([L]: sRGB, [_]: AdobeRGB) ② User-defined 3-digit number ③ File number (4-digits, 0001–9999) ④ File extension



[Select Folder]	Allows selecting a folder for storing images. <ul style="list-style-type: none"> The number of files that can be stored is displayed for the folder name. 	
[Create a New Folder]	Allows creating a new folder by advancing the folder number. <ul style="list-style-type: none"> When no folder for storing images is available on a card, the folder number reset screen is displayed. 	
	[OK]	Allows creating a new folder using the same user-defined 5-digit number comprising a folder name as the current setting.
	[Change]	Allows creating a new folder by entering a new user-defined 5-digit number comprising a folder name to change the current folder name. <ul style="list-style-type: none"> Characters that can be set: uppercase alphanumeric characters, numbers, and [_] For details on how to enter characters, refer to "Entering Text" (→50)
[File Name Setting]	[Folder Number Link]	Allows setting the same number in the folder name to a user-defined 3-digit number in a file name.
	[User Setting]	Allows setting a file name by entering a new user-defined 3-digit number. <ul style="list-style-type: none"> Characters that can be set: uppercase alphanumeric characters, numbers, and [_] For details on how to enter characters, refer to "Entering Text" (→50)

- Up to 1,000 files can be stored in a single folder.
- The serial numbers from 0001 to 9999 are assigned to the files stored in the order in which pictures are taken. When a folder destination is changed, the file is stored with the file number following the preceding file number.
- In the following cases, a new folder is automatically created by advancing the folder number when the next file is saved.
 - When 1,000 files are stored in a folder
 - When a file consisting of the file number of "9999" is stored in a folder
- When folders with numbers from 100 to 999 already all exist, you cannot create a new folder. We recommend saving all necessary pictures to your computer or other devices and formatting the card.



[No.Reset]

Allows resetting picture file numbers. (The folder number is updated and the file number starts from 0001.)

- To reset folder number to 100:
First, format the card, and reset the file numbers using [No.Reset]. Then, select [Yes] on the folder number reset screen.
- A folder number between 100 and 999 can be assigned.
Numbers cannot be reset once the folder number reaches 999. In this case, save all necessary pictures to your computer, and format the card (→26).

[Reset]

Allows resetting the following settings to the default:

- **Recording settings and drive mode**
- **Setup settings ([Wi-Fi Setup] and [Bluetooth] settings)**
- **Custom settings ([Face Recog.] and [Profile Setup] settings)**
- **Setup/custom settings
(except for [Wi-Fi Setup], [Bluetooth], [Face Recog.] and [Profile Setup] settings)**
 - When the setup/custom settings are reset, the following settings are also reset:
 - The [World Time] setting
 - The [Travel Date] setting (Departure date, Return date, [Location])
 - The settings of [Rotate Disp.] and [Picture Sort] in the [Playback] menu
 - Folder numbers and clock settings will not be reset.

[Reset Network Settings]

Allows resetting network settings to the default, such as equipment information you have registered using [Wi-Fi Setup] or [Bluetooth].

MENU →  [Setup]
--

[Level Gauge Adjust.]

■ [Adjust.]

Hold the camera in a horizontal position, and press [MENU/SET]. The level gauge will be adjusted.

■ [Level Gauge Value Reset]

Restores the default level gauge setting.

[My Menu]

Allows you to register frequently used menus and display them on [My Menu]. Up to 23 menus can be registered.

MENU →  [My Menu] → [My Menu Setting]
--

[Add]	For selecting and registering a menu to be displayed on [My Menu].
[Sorting]	For changing the order of the menus to be displayed on [My Menu]. Select the menu whose order you want to change and set the new location.
[Delete]	For deleting a registered menu from the [My Menu] display. [Delete Item]: Selects and deletes a menu from the displayed menus. [Delete All]: Deletes all displayed menus.
[Display from My Menu]	For setting a screen to be displayed when the menu screen is displayed. [ON]: Displays [My Menu] [OFF]: Displays the menu used the previous time

[Playback]

- [Slide Show] (→208)
- [Playback Mode] (→209)
- [Protect] (→210)
- [Rating] (→210)
- [Title Edit] (→211)
- [Face Rec Edit] (→211)
- [RAW Processing] (→212)
- [4K PHOTO Bulk Saving] (→214)
- [Light Composition] (→215)
- [Sequence Composition] (→216)
- [Clear Retouch] (→217)
- [Text Stamp] (→218)
- [Resize] (→219)
- [Cropping] (→220)
- [Rotate] (→220)
- [Video Divide] (→221)
- [Time Lapse Video] (→221)
- [Stop Motion Video] (→222)
- [Rotate Disp.] (→222)
- [Picture Sort] (→222)

● It may not be possible to set or edit pictures taken with other cameras.

■ How to select an image(s) after selecting [Single] or [Multi]

When [Single] and [Multi] are not available, select a picture in the same way as when [Single] is selected.

[Single]

- ① Use ◀▶ to select a picture and press [MENU/SET]
 - If [Set/Cancel] is displayed at the right bottom of the screen, the setting is canceled when [MENU/SET] is pressed again.

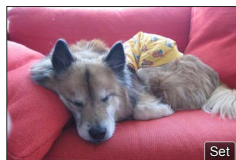

[Multi]

When a screen similar to the one on the right is displayed:

- ① Use ▲▼◀▶ to select a picture and press [MENU/SET] (repeat)
 - To cancel → Press [MENU/SET] again.
- ② Press [DISP] to execute

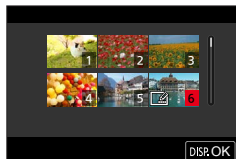

When a screen similar to the one on the right is displayed:

- ① Use ▲▼◀▶ to select a picture and press [MENU/SET] (repeat)
 - To cancel → Press [MENU/SET] again.

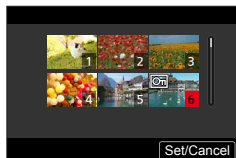

[Slide Show]







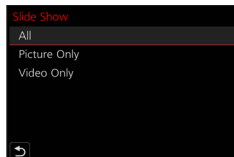

Allows automatically playing back recorded pictures, one after another. You can organize slide shows composed of only pictures or only videos. Recommended when viewing on a TV screen.

MENU →  **[Playback]** → **[Slide Show]**

1 Use ▲ ▼ to select the item and press [MENU/SET]

- If you select [Picture Only], 4K picture series files and pictures recorded using [Post Focus] will also be played back.
- Only an in-focus representative image will be played back from pictures recorded using [Post Focus].

**2 Use ▲ to select [Start] and press [MENU/SET]****■ Operations during Slide Show**

Operation	Touch operation	Description
▲		Play / Pause
◀		Previous
▶		Next
▼		Stop
		Volume up
		Volume down

■ To change settings

Select [Effect] or [Setup] and press [MENU/SET].

[Effect]		This allows you to select the screen effects when switching from one picture to the next.
[Setup]	[Duration]	[Duration] can be set only when [Effect] is set to [OFF].
	[Repeat]	[ON] / [OFF]
	[Sound]	[AUTO]: With pictures, music will play back, and with videos, audio will play back. [Music]: Music effect will play back. [Audio]: Audio is played back from videos. [OFF]: Music and audio will not play back.

- During slide shows of 4K picture series files, pictures recorded in [Post Focus], or group pictures, effects will stay turned off even if [Effect] is set.
- When you play back the following pictures in a slide show, the [Duration] setting is disabled.
 - Videos
 - 4K picture series files
 - Pictures recorded using [Post Focus]
 - Panorama pictures
 - Group pictures

[Playback Mode]

For selecting the type of the pictures and playback. ([Normal Play], [Picture Only], [Video Only])

MENU →  **[Playback]** → **[Playback Mode]**

1 Use ▲ ▼ to select the item and press [MENU/SET]

- If you select [Picture Only], 4K picture series files and pictures recorded using [Post Focus] will also be played back.

[Protect]

For setting protection to disable picture deletion. Prevents deletion of important pictures.

MENU →  **[Playback]** → **[Protect]**

1 Select a picture (→207)**■ To clear all**

Select **[Protect]** → **[Cancel]** → **[Yes]**, and press **[MENU/SET]**



When you set the write-protect switch on the card to the "LOCK" position, the picture is not erased.

- By formatting, the picture is erased even if it is protected.
- This protection may not be effective when using other devices.

[Rating]

You can label the pictures in five levels (ratings). When you have performed **[Rating]**, the following operations will be available.

- Deleting all pictures except the labelled pictures.
- You can check the rating level of the pictures by displaying the details of the file on Windows 8, Windows 8.1, and Windows 10 (only JPEG pictures).

MENU →  **[Playback]** → **[Rating]**

1 Select picture (→207)**2 Use**   **to set the Rating levels (1 to 5) and press [MENU/SET]**

(Repeat steps **1** and **2** to perform the setting with **[Multi.]**)

■ To clear all

Select **[Rating]** → **[Cancel]** → **[Yes]**, and press **[MENU/SET]**

- When you have performed **[Rating]** for group pictures, the setting applies to all pictures in the group, and the number rating set is shown on the rating settings icon of the first picture. If the total number of pictures is 1,000 or higher, [999+] is displayed.
- Only when **[Playback Mode]** is set to **[Normal Play]**, you can select **[Cancel]**.

[Title Edit]

Allows you to enter characters (titles etc.) on a recorded picture. After text has been registered, it can be stamped in prints using [Text Stamp] (→218).

MENU →  **[Playback]** → **[Title Edit]**

1 Select a picture (→207)

-  is displayed for pictures with texts already stamped.

2 Enter characters

- For details on how to enter characters, refer to “Entering Text” (→50)
- To delete texts, delete all the characters in the character input screen.

- You can set up to 100 pictures at one time with [Multi].
- This function is not available in the following cases:
 - Videos
 - 4K picture series files
 - Pictures recorded using [Post Focus]
 - Pictures recorded with the [Quality] setting [RAW:iii], [RAW:ii.] or [RAW]

[Face Rec Edit]

For editing or deleting the recognition information for pictures with incorrect information.

MENU →  **[Playback]** → **[Face Rec Edit]** → **[REPLACE]** or **[DELETE]**

1 Use ◀▶ to select picture and press [MENU/SET]**2 Use ◀▶ to select a person and press [MENU/SET]**

- If [DELETE], go to step 4.

3 Use ▲▼◀▶ to select the person to replace for another and press [MENU/SET]**4 Use ◀ to select [Yes] and press [MENU/SET]**

- When Face Recognition information is deleted, it cannot be restored.
- Edit the Face Recognition information in group units for a picture group. (You cannot edit the information for each picture in a group.)
- You can edit only the first picture in a group.

[RAW Processing]

You can use the camera to edit pictures that were recorded in RAW format. The created pictures are saved in JPEG format.

MENU →  **[Playback]** → **[RAW Processing]**

- 1 Press **◀▶** to select RAW file and then **[MENU/SET]**
- 2 Press **▲▼** to select the item and then **[MENU/SET]** to set

- The following items can be set. The settings used during recording are applied at the time of setting.

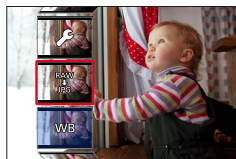

[White Balance]	Allows you to select White Balance to make adjustments. When you select an item with  , you can edit the pictures using the same settings that were applied for recording.
[Brightness correction]	Allows you to correct brightness in the range from -2 EV to +2 EV.
[Photo Style]	Allows you to select the [Photo Style] effects.
[i.Dynamic]	Allows you to select the [i.Dynamic] settings.
[Contrast]	Allows you to adjust the contrast.
[Highlight]	Allows you to adjust the brightness of a highlighted area.
[Shadow]	Allows you to adjust the brightness of a shadowed area.
[Saturation] / [Color Tone]	Allows you to adjust the saturation. (You can adjust the coloring when [Monochrome] or [Monochrome HC] is selected for [Photo Style].)
[Filter Effect]	Allows you to select a Filter effect. (Only when [Monochrome] or [Monochrome HC] is selected for [Photo Style].)
[Noise Reduction]	Allows you to set noise reduction.
[i.Resolution]	Allows you to select the [i.Resolution] settings.
[Sharpness]	Allows you to adjust the impression of resolution.
[More Settings]	Use ▲▼ to select items and press [MENU/SET] to perform the following operations. [Reinstate Adjustments] : Restores the settings to the ones used during recording. [Color Space] : Allows you to select [Color Space] from either [sRGB] or [AdobeRGB]. [Picture Size] : Allows you to select the resolution ([L], [M], or [S]) of a JPEG file when saving pictures.

3 Press [MENU/SET] to finalize the setting

- The screen in step 2 reappears. To set another item, repeat steps 2 to 3.

4 Press ▲ ▼ to select [Begin Processing] and then [MENU/SET]**■ Setting each item**

When you select an item, the setting screen appears.

Operation	Touch operation	Description
	Drag	Used to make adjustments
▲	[WB K Set]	Used to display the color temperature setting screen (Only when [White Balance] is set to [K])
▼	[Adjust.]	Used to display the White Balance fine adjustment screen (Only when [White Balance] is set)
[DISP]	[DISP.]	Used to display the comparison screen
[MENU/SET]	[Set]	Used to finalize an adjustment you just made and to return to the item selection screen



- If you have selected [Noise Reduction], [i.Resolution], or [Sharpness], the comparison screen is not displayed.
- Pictures can be enlarged by operating the zoom lever.
- You can also zoom in by quickly touching the monitor screen twice at the desired point. (If the display was enlarged, it returns to the same magnification ratio.)

The following operating methods are available to make adjustments on the comparison screen.

Ⓐ Current setting

Operation	Touch operation	Description
	Drag	Used to make adjustments
[DISP]	[DISP.]	Used to return to the setting screen
[MENU/SET]	[Set]	Used to finalize an adjustment you just made and to return to the item selection screen

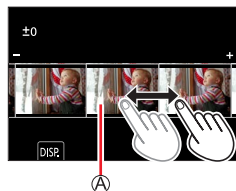

- If you touch the picture at the center, it will be enlarged. If you touch [↵], the picture will be reduced to the original size.

- A RAW image recorded by this camera is always recorded with the aspect ratio set to [3:2] (5472×3648), but if you perform [RAW Processing] from the [Playback] menu, the picture will be processed with the aspect ratio fixed as that at the time of recording.
- The [White Balance] setting of pictures recorded using [Multi Exp.] is fixed to the setting used during recording.
- Edit group pictures one by one. The edited pictures will be newly saved separately from the original group pictures.
- When an HDMI micro cable is connected, [RAW Processing] is disabled.
- You can only perform RAW processing of pictures recorded by this camera.

[4K PHOTO Bulk Saving]

You can bulk save 5 seconds' worth of 4K recording from a 4K picture series file.

MENU →  **[Playback]** → **[4K PHOTO Bulk Saving]**

- 1 Use ◀▶ to select the 4K picture series files and press [MENU/SET]**
 - If the total recording time is 5 seconds or less, all the frames can be saved as a picture.
- 2 Select the first frame to be bulk saved as a picture (→112, 113)**
 - The picture will be saved in JPEG format as a single burst picture group.

[Light Composition]

Allows you to select multiple frames from 4K picture series files that you wish to combine. Parts of the image that are brighter than the preceding frame will be superimposed on the preceding frame to combine the frames into one picture.



MENU → [Playback] → **[Light Composition]**

1 Use ◀▶ to select the 4K picture series files and press **[MENU/SET]**

2 Choose the combining method and press **[MENU/SET]**

■ **[Composite Merging]: Selecting frames to combine**

① Drag the slide bar or use ▲▼◀▶ to select the frames to combine

② Press **[MENU/SET]**

- The selected frames are remembered, and the display goes to the preview screen.
- Use ▲▼ to select items and press **[MENU/SET]** to perform the following operations.
 - [Next]: Lets you select more frames for combining.
 - [Reselect]: Discards the frame selected immediately before and lets you select a different image.



③ Repeat steps ① - ② to select more frames to combine (up to 40 frames)

④ Press ▼ to select **[Save]**, and then **[MENU/SET]**

■ **[Range Merging]: Selecting a range to combine**

① Select the frame of the first picture and press **[MENU/SET]**

- The selection method is the same as in step ① of [Composite Merging] setting.

② Select the frame of the last picture and press **[MENU/SET]**

3 Select **[Yes]** at the confirmation screen and press **[MENU/SET]**

- Pictures are saved in JPEG format. Recording information (Exif information) of the first frame such as shutter speed, aperture, and ISO sensitivity are also registered.

[Sequence Composition]

Allows you to select multiple frames from a 4K picture series file to create a sequence composition of a moving subject into one picture.



MENU → **[Playback]** → **[Sequence Composition]**

1 Use to select the 4K picture series files and press **[MENU/SET]**

2 Select the frames to combine

Select the frames so that the moving subject will not overlap on the preceding or subsequent frames. (The sequence composition may not be created properly if the subject overlaps.)

① Drag the slide bar or use to select the frames to combine

② Press **[MENU/SET]**

- The selected frames are remembered, and the display goes to the preview screen.
- Use to select items and press **[MENU/SET]** to perform the following operations.
 - **[Next]**: Lets you select more frames for combining.
 - **[Reselect]**: Discards the frame selected immediately before and lets you select a different image.

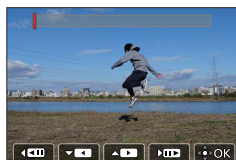

③ Repeat steps ① - ② to select more frames to combine (from 3 to 40 frames)

④ Press to select **[Save]**, and then **[MENU/SET]**

3 Select **[Yes]** at the confirmation screen and press **[MENU/SET]**

- Pictures are saved in JPEG format. Recording information (Exif information) of the first frame such as shutter speed, aperture, and ISO sensitivity are also registered.



Tips for [Sequence Composition]

We recommend using a tripod to take pictures for [Sequence Composition].

[Clear Retouch]

Allows you to erase unnecessary parts recorded on the pictures.

- The erasing operation can only be performed by touching. [Clear Retouch] automatically enables touch operation.



MENU → [▶] **[Playback]** → **[Clear Retouch]**

1 Use ◀▶ to select a picture and press [MENU/SET]**2 Drag your finger over the part you want to erase**

- The parts to be erased are colored.
- Touching [Undo] will return the colored part back to its previous state.

**Erasing details (enlarging the display)****① Touch [SCALING]**

- On the touch screen, spread two fingers to zoom in, or pinch two fingers to zoom out.
- Dragging the screen allows you to move the enlarged part.

② Touch [REMOVE]

- This will bring you back to the operation of dragging your finger over the part you want to erase. The part you want to erase can be dragged even while the picture is enlarged.

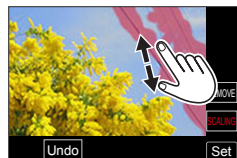
**3 Touch [Set]****4 Touch [Save] or press [MENU/SET]**

- Pictures may appear unnatural because the background of deleted parts is artificially created.
- Edit group pictures one by one. The edited pictures will be newly saved separately from the original group pictures.
- This function is not available when the viewfinder is in use.
- When an HDMI micro cable is connected, [Clear Retouch] is disabled.
- This function is not available in the following cases:
 - Panorama pictures
 - Videos
 - 4K picture series files
 - Pictures recorded using [Post Focus]
 - Pictures recorded with the [Quality] setting [RAW]

[Text Stamp]



Allows you to stamp the recording date and time, names, travel destination, travel dates, etc. on the recorded pictures.

MENU →  **[Playback]** → **[Text Stamp]**

1 Select a picture (→207)

-  appears on screen if the picture is stamped with text.

2 Use ▼ to select [Set] and press [MENU/SET]

[Shooting Date]	[W/O TIME]: Stamp recording date [WITH TIME]: Stamp recording date and time
[Name]	 : Stamp name registered in Face Recognition  : Stamp name registered in [Profile Setup]
[Location]	Stamp location registered in [Setup] menu's [Travel Date]
[Travel Date]	Stamp number of days that have elapsed since the travel date set in [Setup] menu's [Travel Date]
[Title]	Stamp text registered in [Title Edit]

3 Press [Q.M|↵]

4 Use ▲ to select [OK] and press [MENU/SET]

- **Do not request date printing in store or make date printing on printer for pictures with date stamps. (Date printing may be overlapped.)**
- You can set up to 100 pictures at one time with [Multi].
- The picture quality may be 'grainier'.
- If you stamp text on the pictures in a group, the edited pictures will be newly saved separately from the original group pictures.
- This function is not available in the following cases:
 - Videos
 - 4K picture series files
 - Pictures recorded using [Post Focus]
 - Pictures recorded with the [Quality] setting [RAW]
 - Panorama pictures
 - Pictures that other texts had already been stamped
 - Pictures taken without setting clock

[Resize]

Allows you to reduce a picture's resolution to facilitate e-mail attachment and use in web pages, etc.

MENU → **▶** **[Playback]** → **[Resize]**

1 Select a picture and the resolution

[Single]

- ① Use **◀▶** to select a picture and press [MENU/SET]
- ② Use **▲▼** to select the desired resolution and press [MENU/SET]



[Multi] (up to 100 pictures)

- ① Use **▲▼** to select the desired resolution and press [MENU/SET]
- ② Use **▲▼◀▶** to select a picture and press [MENU/SET] (repeat)
 - To cancel → Press [MENU/SET] again.
- ③ Press [DISP] to execute

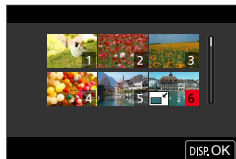

- Picture quality is reduced after resizing.
- This function is not available in the following cases:
 - Videos
 - 4K picture series files
 - Pictures recorded using [Post Focus]
 - Pictures recorded with the [Quality] setting [RAW]
 - Panorama pictures
 - Group pictures
 - Pictures that other texts had already been stamped





[Cropping]

Allows you to enlarge your pictures and crop out unwanted areas.

[MENU] → **[▶]** **[Playback]** → **[Cropping]**

1 Use **◀▶** to select a picture and press **[MENU/SET]**

2 Select the area to crop and press **[MENU/SET]**

Operation	Touch operation	Description
		Enlarges the picture
		Reduces the picture
	Drag	Moves the enlarged area

- Edit group pictures one by one. The edited pictures will be newly saved separately from the original group pictures.
- Original Face Recognition information will not be copied when pictures are cropped.
- Picture quality is reduced after cropping.
- This function is not available in the following cases:
 - Videos
 - 4K picture series files
 - Pictures recorded using [Post Focus]
 - Pictures recorded with the [Quality] setting [RAW]
 - Panorama pictures
 - Pictures that other texts had already been stamped

[Rotate]

Allows you to manually rotate the picture in 90-degree steps.

- You cannot select [Rotate] when [Rotate Disp.] is set to [OFF].

[MENU] → **[▶]** **[Playback]** → **[Rotate]**

1 Use **◀▶** to select a picture and press **[MENU/SET]**

2 Use **▲▼** to select the rotation direction and press **[MENU/SET]**

[↷]: Rotate a picture 90 degrees clockwise.

[↶]: Rotate a picture 90 degrees counterclockwise.





[Video Divide]

A single video can be split into 2 parts. This is convenient when you want to keep just the necessary scenes, or if you wish to delete unnecessary scenes to increase free space on your card, such as when traveling.

MENU →  **[Playback]** → **[Video Divide]**

1 Use   to select a video to split and press **[MENU/SET]**

2 Press  at where you want to split the video to pause it

- If you press   while paused, you can make finer adjustments to the splitting positions.

3 Press 

- **The original video that was split is not retained.**
(There will only be the 2 videos that were created by the split.)



- During dividing, do not turn off the camera or remove the card or battery. If you do so, the video may be deleted.
- Videos cannot be divided at a location close to their start or their end.
- This function is not available in the following case:
 - Videos with a short recording time

[Time Lapse Video]

Allows you to create a video from the pictures in a group that were recorded using [Time Lapse Shot].

MENU →  **[Playback]** → **[Time Lapse Video]**

1 Use   to select the [Time Lapse Shot] picture group and press **[MENU/SET]**

2 Create a video after selecting a production method

- For details, refer to step **5** and the subsequent steps (→132).

[Stop Motion Video]

Allows you to create a video from the pictures in a group that were recorded using [Stop Motion Animation].

MENU →  **[Playback]** → **[Stop Motion Video]**

1 Use ◀▶ to select a stop motion animation group and press **[MENU/SET]**

2 Create a video after selecting a production method

- For details, refer to step **8** and the subsequent steps (→135).

[Rotate Disp.]

This mode allows you to display pictures vertically if they were recorded holding the camera vertically.

MENU →  **[Playback]** → **[Rotate Disp.]** → **[ON]**

- When you play back pictures on a PC, they cannot be displayed in the rotated direction unless the OS or software is compatible with Exif. Exif is a file format for pictures which allows recording information, etc. to be added. It was established by "JEITA (Japan Electronics and Information Technology Industries Association)".

[Picture Sort]

Allows you to set the display sequence used for playing back pictures on this camera.

MENU →  **[Playback]** → **[Picture Sort]**

[FILE NAME]	Displays pictures in the folder name or file name sequence. This display format allows you to find the storage location of a picture on a card more easily.
[DATE/TIME]	Displays pictures according to the date and time they were taken in chronological order. When the pictures were taken using several cameras and stored on the same card, this display format allows you to find a specific picture more easily.

- Pictures may not be displayed according to the **[DATE/TIME]** sequence immediately after a card is inserted into this camera. In that case, wait a while, and the pictures will be displayed in the **[DATE/TIME]** sequence.

What you can do with the Wi-Fi®/Bluetooth® function

Operating the camera by connecting it to a smartphone

- Tripping the camera's shutter using a smartphone (remote recording) (→236)
- Playing back or saving images stored on the camera (iOS devices) (→240)
- Playing back or saving images stored on the camera, or uploading them on social media sites (Android devices) (→240)

Expanding the scope of applications by connecting the camera to a smartphone compatible with Bluetooth Low Energy

- Pairing (connection setup) (→228)
 - Turning on/off the camera using a smartphone (→235)
 - [B] (Bulb) recording (→238)
 - Transferring recorded images to a smartphone automatically (→241)
 - Writing location information of a smartphone on a recorded image (→243)
 - Synchronizing the camera's clock with a smartphone (→244)
- These instructions uses the term "smartphone" for both smartphones and tablets unless it is necessary to distinguish between them.

Wi-Fi/Bluetooth Function

■ Before Use

- Complete the date and time settings in advance. (→28)
- To use the Wi-Fi function on this camera, a wireless access point or a destination device equipped with the wireless LAN function is required.

■ Lighting of the WIRELESS connection lamp (Blue)

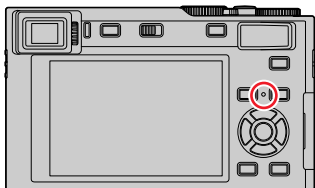

Lit: When the Wi-Fi/Bluetooth function is ON or connected

Flashing: When sending picture data

- In [Wireless Connection Lamp] in the [Setup] menu, you can set the lamp so that it will not light/flash. (→198)

■ [Wi-Fi] button

In these instructions, the function button to which [Wi-Fi] is assigned is referred to as the [Wi-Fi] button. (At the time of purchase, [Wi-Fi] is assigned to [Fn5] in recording mode, and [Fn1] in playback mode.)

- For details on the function buttons, refer to (→46).

To start up the Wi-Fi function (When in recording mode):

① Touch [Fn]



② Touch [Fn5]



■ Operations that can be performed by pressing the [Wi-Fi] button

If you press the [Wi-Fi] button when you do not have a Wi-Fi connection, the camera enters a standby mode in which it can connect directly to the smartphone. (→230)

- If you press [DISP] at that time, you can select a destination from the history of previous connections and quickly connect. (→253)

When the camera is connected to Wi-Fi, you can press the [Wi-Fi] button and perform the following operations.

[Terminate the Connection]	Terminates the Wi-Fi connection.
[Change the Destination]	Terminates the Wi-Fi connection, and allows you to select a different Wi-Fi connection.
[Change Settings for Sending Images]	For details (→248).
[Register the Current Destination to Favorite]	Registers the current connection destination or the connection method, so you can easily connect with the same connection method next time.
[Network Address]	For details (→255).

- Depending on the Wi-Fi function being used or the connection destination, you may not be able to perform some of these operations.

■ Describing method

When selecting “[Select a destination from History]”, etc. is described in a step, perform any of the following operations.

With cursor button operations

Use cursor buttons to select [Select a destination from History] and press [MENU/SET].

With touch screen operations

Touch [Select a destination from History].

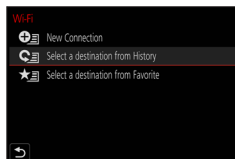



- **Do not remove the memory card or battery or move to an area without any reception while sending images.**
- The camera cannot be used to connect to a public wireless LAN connection.
- We recommend that you use a fully charged battery when you send pictures.
- When sending images on a mobile network, high packet communication fees may be incurred depending on the details of your contract.
- Pictures may not be completely sent depending on transmission conditions. If the connection is terminated while sending pictures, pictures with missing sections may be sent.

Connecting the camera to a smartphone

You can remotely operate the camera using a smartphone.
The “Leica C-Lux” app must be installed on your smartphone.

Installing the smartphone/tablet app “Leica C-Lux”

The “Leica C-Lux” app is an application provided by Leica Camera AG that allows your smartphone to perform the following operations of a Wi-Fi-compatible Leica compact digital camera.

	For Android™ apps	For iOS apps
Supported OS	Android 4.2 or later (Android 5.0 or higher is required to use the Bluetooth function)	iOS 9.0 or later (The Bluetooth function cannot be used with the iPad 2)
Installation procedure	<ol style="list-style-type: none"> ① Connect your Android device to a network ② Select “Google Play™ Store”* ③ Enter “Leica C-Lux” into the search box ④ Select “Leica C-Lux” and install it <ul style="list-style-type: none"> • The icon will be added to the menu.  <p>* Not available in China. To download in China, please visit the site below: www.leica-camera.com</p>	<ol style="list-style-type: none"> ① Connect the iOS device to the network ② Select “App Store” ③ Enter “Leica C-Lux” into the search box ④ Select “Leica C-Lux” and install it <ul style="list-style-type: none"> • The icon will be added to the menu. 

- Use the latest version.
- Supported OS versions as of June 2018. Supported OS versions may be changed without prior notice.
- The service may not be able to be used properly depending on the type of smartphone being used.
- When downloading the app on a mobile phone network, high packet communication fees may be incurred depending on the details of your contract.
- Some of the screens and information provided in this document may be different depending on the supported operating system and “Leica C-Lux” app version.

Connecting the camera to a smartphone

Connecting the camera to a smartphone compatible with Bluetooth Low Energy

You can connect the camera to a smartphone via a Bluetooth connection.

Supported smartphones

Android: Android 5.0 or higher equipped with Bluetooth 4.0 or higher
(excluding those that do not support Bluetooth low energy)
iOS: iOS 9.0 or higher (excluding the iPad 2)

■ First-time connection

You need to set up pairing (connection) for the first time only. When pairing is set up, a Wi-Fi connection is made automatically.

(On the camera)

MENU →  **[Setup]** → **[Bluetooth]** → **[Bluetooth]**
→ **[SET]** → **[Pairing]**

- The camera enters pairing standby mode and displays its device name.

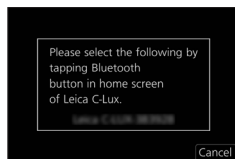

(On your smartphone)

- ① Start the "Leica C-Lux" app
 - If a message is displayed indicating that the smartphone is searching for cameras, close the message.
- ② Select **[Bluetooth]**
- ③ Turn on Bluetooth
- ④ Select the device name displayed on the camera's screen from the **[Camera enable to be registered]** list
 - A Bluetooth connection between the camera and the smartphone will be made.
(For Android devices) A Wi-Fi connection will be made by selecting **[Connection]**.

If you are using an Android device, follow the steps up to here to complete the setup. Proceed to the steps below only if you are using an iOS device (iPhone/iPod touch/iPad).

- If **[Wi-Fi Password]** (→255) is set to **[ON]** on the camera, you need to install the profile. (At the time of purchase, **[Wi-Fi Password]** is set to **[ON]**)
- If **[Wi-Fi Password]** is set to **[OFF]** on the camera, select **[Wi-Fi Setup]**.
 - ① Install the profile
 - If the smartphone is locked with a passcode, enter the passcode to unlock the smartphone.
 - ② Exit the browser

Connecting the camera to a smartphone

- ⑤ Turn on the Wi-Fi function in the setting menu
- ⑥ On the Wi-Fi setting screen, select the SSID displayed on the camera (The device name selected in step ④)
 - If the SSID is not displayed, it may be displayed after the Wi-Fi function is turned off and on.
 - When you need to change the connected device, follow the on-screen message to change the setting.
- ⑦ Start the “Leica C-Lux” app
 - The paired smartphone will be registered as a paired device after connected via Wi-Fi.

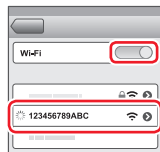

■ Connecting to the paired smartphone (connecting for the second and subsequent times)

(On the camera)

- ① Enable the Bluetooth function

MENU →  **[Setup]** → **[Bluetooth]** → **[Bluetooth]** → **[ON]**

(On your smartphone)

- ② Start the “Leica C-Lux” app
 - If a message is displayed indicating that the smartphone is searching for cameras, close the message.
- ③ Select **[Bluetooth]**
- ④ Turn on Bluetooth
- ⑤ Select the device name displayed on the camera’s screen from the **[Camera registered]** list
 - Even if you set up pairing with more than one smartphone, you can only connect to one smartphone at a time.

■ Terminating the Bluetooth connection

MENU →  **[Setup]** → **[Bluetooth]** → **[Bluetooth]** → **[OFF]**

- The connection will be terminated and the camera’s Bluetooth function will be deactivated.
- Even if you terminate the connection, the pairing information for it will not be deleted.

Connecting the camera to a smartphone

■ Deleting the pairing information

(On the camera)



① Set the menu

MENU →  **[Setup]** → **[Bluetooth]** → **[Bluetooth]** → **[SET]** → **[Delete]**

② Select the smartphone you want to delete

(On your smartphone)

Select the camera (device name) for which to delete the pairing information from the [Camera registered] list, and delete the registration.

-  is displayed on the recording screen when a Bluetooth device is connected. If the Bluetooth function is enabled, but the smartphone is not connected, the displayed  is semi-transparent.
- When it takes time to set up pairing between a smartphone and a camera, delete the pairing information of both devices and register them again. This may enable the devices to be recognized properly.
- Up to 16 smartphones can be registered. If you try to register more than 16 devices, the smartphone with the oldest registration history will be replaced.
- Performing [Reset Network Settings] will delete registered device information.

Connecting the camera to a smartphone that does not support Bluetooth Low Energy

Connect to a smartphone via Wi-Fi.

- You can also connect via Wi-Fi to a smartphone that supports Bluetooth low energy by following the same steps.

Using a password to set up a connection

When [Wi-Fi Password] is set to [ON], you can strengthen security by using manual input or a QR code for password authentication.

([Wi-Fi Password] is set to [ON] at the time of purchase.)

Connecting the camera to a smartphone

■ When reading a QR Code to connect (On the camera)

MENU →  **[Setup]** → **[Wi-Fi]** → **[Wi-Fi Function]** → **[New Connection]**
→ **[Remote Shooting & View]**

- Ⓐ SSID and Password
- Ⓑ QR Code

- The information (QR Code, SSID and Password) required for directly connecting your smartphone to this camera is displayed.
- You can also display the information by pressing the [Wi-Fi] button on the camera.

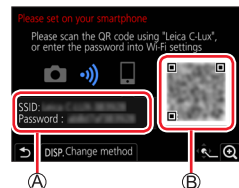

(On your smartphone)

- ① Start the "Leica C-Lux" app
- ② Select "QR code"
 - When the smartphone is connected to a wireless access point, it may take time to display QR code.
 - (For iOS devices) A confirmation screen will be displayed. Select [OK] to proceed.
- ③ Use the "Leica C-Lux" app to scan the QR code displayed on the screen of the camera
 - If you press [MENU/SET] on the camera, the QR code will be enlarged.

If you are using an Android device, follow the steps up to here to complete the setup. Proceed to the steps below only if you are using an iOS device (iPhone/iPod touch/iPad).

- ④ Install the profile
 - If the smartphone is locked with a passcode, enter the passcode to unlock the smartphone.
- ⑤ Exit the browser
- ⑥ Turn on the Wi-Fi function in the setting menu
- ⑦ On the Wi-Fi setting screen, select the SSID displayed on the camera
- ⑧ Start the "Leica C-Lux" app
 - (iOS devices) Steps ① through ⑤ are not required from the second time on.

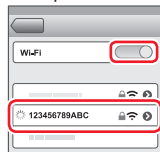

Connecting the camera to a smartphone

Manually entering a password to set up a connection

(On the camera)

MENU → **[Setup]** → **[Wi-Fi]** → **[Wi-Fi Function]** → **[New Connection]**
→ **[Remote Shooting & View]**

- Ⓐ SSID and Password
- Ⓑ QR Code

- The information (QR Code, SSID and Password) required for directly connecting your smartphone to this camera is displayed.
- You can also display the information by pressing the [Wi-Fi] button on the camera.

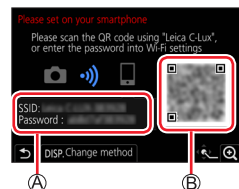

(On your smartphone)

- ① Turn on the Wi-Fi function in the setting menu
- ② On the Wi-Fi setting screen, select the SSID displayed on the camera
- ③ Enter the password displayed on the camera (For first time connection only)
- ④ Start the "Leica C-Lux" app

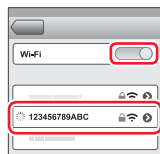

Connecting without using the password

You can easily establish a Wi-Fi connection on this camera without entering a password on your smartphone.

Preparation

(On the camera) Set [Wi-Fi Password] to [OFF]. (→255)

(On the camera)

MENU → **[Setup]** → **[Wi-Fi]** → **[Wi-Fi Function]** → **[New Connection]**
→ **[Remote Shooting & View]**

- Ⓐ SSID

- The information required for directly connecting your smartphone to this camera (SSID) is displayed.
- You can also display the information by pressing [Wi-Fi] button on the camera.



Connecting the camera to a smartphone

(On your smartphone)

- 1 Turn on the Wi-Fi function in the setting menu
- 2 Select the SSID displayed on the screen of the camera
- 3 Start the “Leica C-Lux” app
 - When the connection confirmation screen appears on the camera, select [Yes] and press [MENU/SET]. (Only when making a connection for the first time.)

**When [Wi-Fi Password] is set to [OFF].**

When you start a Wi-Fi connection, be sure to verify that the device displayed on the camera's connection confirmation screen is really the device you want to connect to. Even if the wrong device is displayed, you will still be connected to it if you select “Yes”. If there seem to be other Wi-Fi enabled devices in the vicinity, we recommend that you set [Wi-Fi Password] to [ON] (→255).

Changing the Wi-Fi connection method

To change the connection method, follow the steps below:

[MENU] → [Setup] → [Wi-Fi] → [Wi-Fi Function]
 → [New Connection] → [Remote Shooting & View]
 → [DISP] button

or

[Wi-Fi] → [DISP] button → [New Connection]
 → [Remote Shooting & View] → [DISP] button

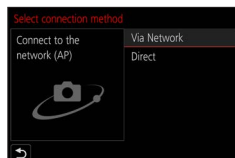

Connecting the camera to a smartphone

■ When connecting with [Via Network]

(On the camera)

- 1 Select [Via Network] and press [MENU/SET]
 - Connect the camera to a wireless access point by following the connection method (→249).

(On your smartphone)

- 2 Turn on the Wi-Fi function in the setting menu
- 3 Select the wireless access point you connected to the camera, and set
- 4 Start the “Leica C-Lux” app

■ When connecting with [Direct]

(On the camera)

- 1 Select [Direct] and press [MENU/SET]
 - Connect the camera to the smartphone by following the connection method (→252).

(On your smartphone)

- 2 Start the “Leica C-Lux” app

Closing the Wi-Fi connection

1 Set the camera to Recording Mode

- Press the shutter button halfway to return to recording mode.

2 Select the camera's menu items to terminate the Wi-Fi connection

MENU →  **[Setup]** → **[Wi-Fi]** → **[Wi-Fi Function]**
→ **[Yes]**

- You can also terminate the connection by pressing the [Wi-Fi] button on the camera.

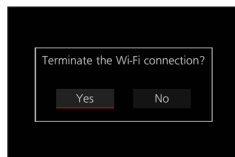

3 On the smartphone, close the “Leica C-Lux” app

- When recording with 4K Pre-series with the smartphone, terminate the connection only after switching to 4K picture series recording by pressing [QM] → [↵] on the camera.

Controlling the Camera with a Smartphone

Required wireless connectivity mode

The wireless connectivity mode required varies depending on the function to be used after connecting to a smartphone.

Wireless connectivity required	Support for Bluetooth low energy
Bluetooth	Indicates that the function can be used with smartphones that support Bluetooth low energy.
Wi-Fi	Indicates that the function can be used with smartphones that do not support Bluetooth low energy.
Bluetooth Wi-Fi	Indicates that the function can be used with smartphones that support Bluetooth low energy. • Indicates that the function requires you to connect to a smartphone using both Bluetooth and Wi-Fi.

Turning on/off the camera using a smartphone

Wireless connectivity required: Bluetooth Wi-Fi

Even when the camera is turned off, you can remotely turn it on and operate it from your smartphone. This function allows you to turn on the camera from a distant location and take pictures or view images on the camera even when it is in your bag.



1 Make a Bluetooth connection to the smartphone (→228)

2 Select the camera's menu

MENU → [Setup] → [Bluetooth] → [Remote Wakeup] → [ON]

3 Set the camera's main switch to [OFF]

4 On the smartphone, start up the "Leica C-Lux" app, and set the Bluetooth function to a state in which a connection can be made (standby state)

5 Operate the smartphone

① Select [Home]





② Select [Remote operation]

- The camera automatically turns on, allowing it to make a Wi-Fi connection automatically.
 - (iOS devices) Depending on the connection status of the smartphone, you may need to change the connected device on the Wi-Fi setup screen. Follow the on-screen message on the smartphone to change the setting.

Controlling the Camera with a Smartphone

■ Turning off the camera with the smartphone

- ① Select []
- ② Select [ OFF]

- When [Remote Wakeup] is set to [ON], the Bluetooth function continues to operate even after the camera is turned off, thus causing the battery to drain.

■ Tripping the camera's shutter using a smartphone (remote recording)

Wireless connectivity required: Wi-Fi

1 Connect to a smartphone (→227)

2 Operate the smartphone

If the camera is already connected to the smartphone via Bluetooth, select [] → [Remote operation].

(iOS devices) Depending on the connection status of the smartphone, you may need to change the connected device on the Wi-Fi setup screen. Follow the on-screen message on the smartphone to change the setting.



- ① Select []



- ② Take the pictures
 - The recorded images are saved in the camera.
 - Some settings are not available.

■ Setting the higher priority between the camera and smartphone to perform operations

MENU →  [Setup] → [Wi-Fi] → [Wi-Fi Setup] → [Priority of Remote Device]

 [Camera]	<p>Allows you to perform operations with both the camera and the smartphone.</p> <ul style="list-style-type: none"> • The camera's dial settings, etc. cannot be changed with the smartphone.
 [Smartphone]	<p>Allows you to perform operations only with the smartphone during remote recording.</p> <ul style="list-style-type: none"> • The camera's dial can also be operated with the smartphone. • To end remote recording, press any of the buttons on the camera to turn on the screen, and select [Cancel].

- The setting of this function cannot be changed while the connection is active.

Controlling the Camera with a Smartphone

- The camera could tilt when the lens barrel extends. Make sure to immobilize the camera with a tripod or by other means.
- This function is not available in the following cases:
 - Panorama Shot Mode (When [Priority of Remote Device] is set to [📱] ([Smartphone]), you can switch temporarily to Program Mode for remote recording only during remote recording.)
 - When using [Time Lapse Shot]

Using the smartphone to operate the camera's shutter via a Bluetooth connection only

Wireless connectivity required: **Bluetooth**

1 Make a Bluetooth connection to the smartphone (→228)

2 Operate the smartphone

① Select [🏠]

② Select [Shutter Remote Control]



③ Take the pictures

- [Shutter Remote Control] is available only when the camera's main switch is set to [ON].
- The Live View screen of the camera cannot be viewed on a smartphone.
- When the camera turns off after [Sleep Mode] is activated during recording, select [Shutter Remote Control] again using the smartphone to turn on the camera once more. (This function is enabled only when [Remote Wakeup] is set to [ON] and [Auto Transfer] is set to [OFF].)



[B] (Bulb) (Approximately up to 120 seconds)

You can perform [B] (Bulb) recording when the shutter speed is set to [T] (time) in Manual Exposure Mode.

This function is useful when you take pictures of stars in the night sky or a night scene, since the shutter can be kept open even for longer exposures.

1 Operate the smartphone

① Press [🔴] to start recording (Press and hold [🔴])

② Release your finger from [🔴] to end recording



- Slide [🔴] in the direction of LOCK to record with the shutter button fixed in the fully pressed condition. (Slide [🔴] back in the opposite direction or press the shutter button of the camera to end recording.)
- If Bluetooth is disconnected during the [B] (Bulb) recording, reconnect Bluetooth and perform the operation to end recording using the smartphone.
- "[T] (time)" will be displayed on the camera screen.

Controlling the Camera with a Smartphone

■ Reducing the time to recover from Sleep mode

Select the smartphone function to be used as a priority function when waking the camera from [Sleep Mode] with a smartphone.

Preparation

Set [Bluetooth] and [Remote Wakeup] to [ON]. (→235)

MENU →  **[Setup]** → **[Bluetooth]** → **[Returning from Sleep Mode]**



[Remote / Transfer Priority]

Shortens the time required to wake the camera with [Remote operation] or [Transfer image].



[Shutter Remote Priority]

Shortens the time required to wake the camera with [Shutter Remote Control].

Playing back or saving images stored in the camera, or uploading them on social media sites

Wireless connectivity required: Wi-Fi

1 Connect to a smartphone (→227)

2 Operate the smartphone

If the camera is already connected to the smartphone via Bluetooth, select [] → [Remote operation].

(iOS devices) Depending on the connection status of the smartphone, you may need to change the connected device on the Wi-Fi setup screen. Follow the on-screen message on the smartphone to change the setting.

① Select []

- You can switch a device of pictures to be displayed using the icon at the top left on the screen. Select [Leica] to display a picture saved in the camera.

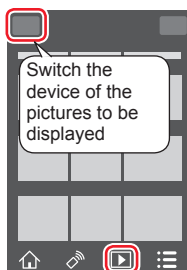

(Playing back a picture)

② When the picture is touched, it is played back at a larger size

- When playing back videos, the data size is reduced during transmission to the “Leica C-Lux” app. Therefore, the picture quality may be different from the actual video you have recorded. Depending on your smartphone and its usage environment, you may notice degradation in the picture quality or skipping of sound when playing back videos and pictures.

(Saving and sending pictures to web services such as SNS)*

* For iOS devices, you can save a picture only to the smartphone.

③ Press and hold the picture and drag it

- MP4 videos for which the [Rec Quality] size is [4K], 4K picture series files, and pictures recorded with [Post Focus] cannot be saved.
- RAW-format pictures can be saved only on smartphones with Android 7.0 or higher or iOS 10.0 or higher. The pictures, however, may not be displayed correctly on some smartphones or some versions of operating systems.

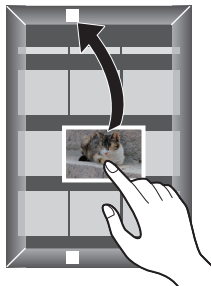

Transferring recorded images to a smartphone automatically

Wireless connectivity required: **Bluetooth** **Wi-Fi**

The camera automatically transfers recorded images to a Bluetooth-connected smartphone via Wi-Fi.

1 Make a Bluetooth connection to the smartphone (→228)

2 Select the camera's menu

MENU →  **[Setup]** → **[Bluetooth]** → **[Auto Transfer]** → **[ON]**

- If a confirmation screen is displayed on the camera asking you to terminate the Wi-Fi connection, select [Yes] to terminate it.

3 On the smartphone, select [YES] (Android devices) or [Wi-Fi Setup] (iOS devices)

- The camera automatically makes a Wi-Fi connection.
 - (iOS devices) Follow the on-screen message on the smartphone to change the connected device on the Wi-Fi setup screen.

4 Check the send settings on the camera, and select [Set]

- To change the send setting, press [DISP]. (→248)
- The camera will enter a mode where it can automatically transfer images and  will be displayed on the recording screen. (If [Auto Transfer] is not displayed on the recording screen, images cannot be transferred automatically. Check the status of the Wi-Fi connections to the smartphone.)

5 Take pictures with the camera

- Every time you take a picture, it is automatically sent to a specified device.
- While sending a file,  is displayed on the recording screen.



If you set [Auto Transfer] to [ON] in advance, the Wi-Fi/Bluetooth connection will be automatically established and Auto Transfer enabled the next time you turn on the camera and start up the "Leica C-Lux" app on your smartphone.

■ To stop the automatic transfer of images

In step **2**, select [OFF].

- A confirmation screen is displayed, asking you to terminate the Wi-Fi connection.

- **When [Auto Transfer] in [Bluetooth] is set to [ON], [Wi-Fi Function] is disabled.**
- If the file transfer is interrupted because the camera turns off, turn the camera on again to restart file transfer.
 - You may not be able to resend the files that did not get delivered if there is a change in their storage status. For example, if you replace the card before turning on the camera again, the files may not be resent.
 - If the number of files that did not get delivered is large, it may not be possible to resend all of the files.
- Videos, 4K picture series files, and pictures recorded with [Post Focus] cannot be automatically transferred.
- RAW-format pictures can be saved only on smartphones with Android 7.0 or higher or iOS 10.0 or higher. The pictures, however, may not be displayed correctly on some smartphones or some versions of operating systems.

Writing location information of a smartphone on a recorded image

Wireless connectivity required: **Bluetooth**

The smartphone sends its location information to the camera via Bluetooth, and the camera performs recording while writing the acquired location information.

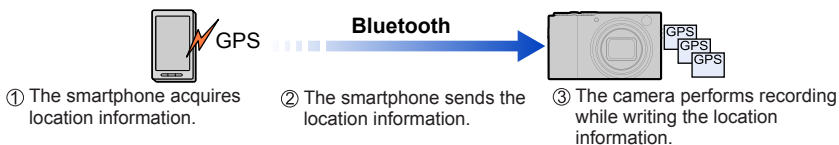

Preparation

Enable the GPS function on the smartphone.

1 Make a Bluetooth connection to the smartphone (→228)

2 Select the camera's menu

MENU → **[Setup]** → **[Bluetooth]** → **[Location Logging]** → **[ON]**

- The camera will enter a mode where location information can be recorded and **[GPS]** will be displayed on the recording screen.

3 Take pictures on the camera

- Location information will be written to the recorded pictures.

When the displayed **[GPS]** is semi-transparent

Location information is not acquired, so data cannot be written. Positioning with the GPS on the smartphone may not be possible if the smartphone is in a location such as a building or a bag. Move the smartphone to a location where positioning performance can be optimized, such as that offers a wide view of the sky, to try positioning. In addition, refer to the instructions of your smartphone.

- Images with location information are indicated with **[GPS]**.
- **Be sure to pay special attention to the privacy, the likeness rights, etc. of the subject when you use this function. Use at your own risk.**
- The smartphone battery drains faster while location information is being recorded.

Synchronizing the camera's clock with a smartphone

Wireless connectivity required: **Bluetooth**

Synchronize the [Clock Set] setting in the [Setup] menu and [Home] or [Destination] setting in the [World Time] of the camera with those of a smartphone.

1 Make a Bluetooth connection to the smartphone (→228)

2 Select the camera's menu

MENU →  [Setup] → [Bluetooth] → [Auto Clock Set] → [ON]

Sending pictures to a smartphone

■ Images that can be sent

JPEG	RAW*1	MP4*2, *3	4K Picture Series file Pictures recorded in [Post Focus]
○	○	○	—

*1 An Android 7.0 or higher or iOS 10.0 or higher operating system is required.

*2 Sending by [Send Images While Recording] is not available.

*3 Excluding videos recorded with [Rec Quality] of [4K].

- Some images may not be played back or sent depending on the device.
- For more information about picture playback, see the instructions of the destination device to which you will send the pictures.

Sending pictures to a smartphone

Preparation

Install the "Leica C-Lux" app in advance. (→227)

MENU →  **[Setup]** → **[Wi-Fi]** → **[Wi-Fi Function]** → **[New Connection]**
→ **[Send Images While Recording]** / **[Send Images Stored in the Camera]**

1 Select [Via Network] or [Direct] to connect (→249, 252)

(On your smartphone)

■ When connecting with [Via Network]

- ① Set Wi-Fi function to "ON"
- ② Select a wireless access point and set
- ③ Start the "Leica C-Lux" app

■ When connecting with [WPS Connection]* in [Direct]

- ① Start the "Leica C-Lux" app

* WPS refers to a function that allows you to easily configure the settings related to the connection and security of wireless LAN devices. To check if the smartphone you are using is compatible with WPS, refer to the instructions of the smartphone.

■ When connecting with [Manual Connection] in [Direct]

- ① Set Wi-Fi function to "ON"
- ② Select the SSID displayed on this camera
- ③ Start the "Leica C-Lux" app

2 Select the device you wish to connect to**3 Check the send settings, and select [Set]**

- To change the send setting, press [DISP]. (→248)

[Send Images While Recording]**4 Take a picture (→247)****[Send Images Stored in the Camera]****4 Select the picture (→248)**

- When [Auto Transfer] in the [Bluetooth] is set to [ON], [Wi-Fi Function] is disabled.

Sending pictures to a smartphone

[Send Images While Recording]

A picture can be automatically sent to a specified device every time you take it.

- [Wi-Fi] is displayed on the recording screen while connected by [Send Images While Recording], and [Send] is displayed while files are being sent.
- To terminate the connection, follow the steps below:

MENU → [Setup] → [Wi-Fi] → [Wi-Fi Function] → [Yes]

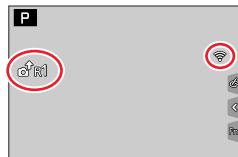

- You cannot change the settings while sending a picture.
- Since the camera gives priority to recording, sending may take longer during the recording.
 - If you turn off the camera before you have completed sending, or if you close the Wi-Fi connection, or in similar situations, unsent files will not be resent.
 - You may not be able to delete files or use the [Playback] menu while sending.
 - If you set [Time Lapse Shot], the Wi-Fi connection is terminated and you cannot use this function.

Sending pictures to a smartphone

[Send Images Stored in the Camera]

You can select and send recorded images.

When selecting [Single Select]

- ① Select the picture
- ② Select [Set]

**When selecting [Multi Select]**

- ① Select the picture (repeat)
 - If selected again, the setting will be canceled.
- ② Select [OK]

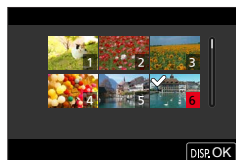

- To close the connection, select [Exit].

- Some images taken with a different camera may not be able to be sent.
- Images that have been modified or edited with a computer may not be able to be sent.

Changing the settings for sending images

After you have completed connecting, you can change the send settings, such as the size of pictures to be sent, by pressing [DISP].

[Size]	Resize the image to send. [Original] / [Change] ([M], [S], [VGA])
[File Format]	[JPG] / [RAW+JPG] / [RAW]

About Wi-Fi connections

The following types of connections are available.

MENU →  **[Setup]** → **[Wi-Fi]** → **[Wi-Fi Function]**

[New Connection]

A connection is made by selecting a Wi-Fi function and the connected device. When the following screen is displayed, select either **[Via Network]** (→249) or **[Direct]** (→252) and make a connection.

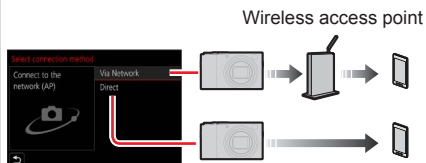

[Select a destination from History] /
[Select a destination from Favorite]

A connection is made using the same settings as the previous time. (→253)

Connecting via a wireless access point ([Via Network])

Select a connection method to the wireless access point.

[WPS (Push-Button)]	Saves push button type wireless access point that is compatible with Wi-Fi Protected Setup™ with a WPS mark.
	1 Press the wireless access point WPS button until it switches to WPS Mode
[WPS (PIN code)]	Saves PIN code type wireless access point that is compatible with Wi-Fi Protected Setup with a WPS mark.
	1 On the camera screen, select the wireless access point you are connecting to
	2 Enter the PIN code displayed on the camera screen into the wireless access point
	3 Press [MENU/SET] on the camera
[From List]	Select this option when you are not sure about the WPS compatibility, or when you want to search for and connect to a wireless access point. (→250)

- The settings screen will only appear during the first connection. Connection methods set on this camera are stored and will be used for subsequent connections. If you want to change the wireless access point to connect to, press [DISP], then change the connecting destination.
- WPS refers to a function that allows you to easily configure the settings related to the connection and security of wireless LAN devices. To check if the wireless access point you are using is compatible with WPS, refer to the instructions of the wireless access point.

If you are not sure about the WPS compatibility (connecting by [From List])

Search for available wireless access points.

- Confirm the encryption key of the selected wireless access point if the network authentication is encrypted.

1 Select the wireless access point you are connecting to

- Pressing [DISP] will search for a wireless access point again.
- If no wireless access point is found, refer to "When connecting with [Manual Input]". (→251)

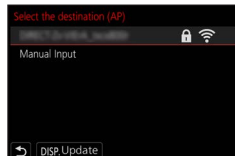

2 (If network authentication is encrypted) Enter the encryption key

- For details on how to enter characters, refer to "Entering Text" (→50)

■ When connecting with [Manual Input]

- When connecting by [Manual Input], confirm SSID, network authentication type, encryption type, encryption key of the wireless access point you are using.
- ① On the screen of step **1** of “If you are not sure about the WPS compatibility (connecting by [From List])”, select [Manual Input]
 - ② Enter the SSID of the wireless access point you are connecting to, then select [Set]
 - For details on how to enter characters, refer to “Entering Text” (→50)
 - ③ Select the network authentication type

[WPA2-PSK]	Supported encryption methods: [TKIP] / [AES]
[WPA2/WPA-PSK]	
[No Encryption]	—

- ④ (When an option other than [No Encryption] is selected)
Enter the encryption key

- Check the wireless access points instructions and settings when saving a wireless access point.
- If no connection can be established, the wireless access point's transmission may be too weak. Refer to “Message displays” (→276) and “Q&A Troubleshooting” (→282) for details.
- Transmission speed may decrease, or may not be usable depending on the environment it is used in.

Connecting directly ([Direct])

You can directly connect the camera to your device.

[WPS Connection]	<p>[WPS (Push-Button)]</p> <ol style="list-style-type: none"> 1 On the camera screen, select [WPS (Push-Button)] 2 Set the device to WPS mode <ul style="list-style-type: none"> You can extend waiting time for a connection by pressing [DISP] on this camera. <p>[WPS (PIN code)]</p> <ol style="list-style-type: none"> 1 On the camera screen, select [WPS (PIN code)] 2 Enter the PIN code of the device into the camera
[Manual Connection]	<ol style="list-style-type: none"> 1 Enter the SSID and password into the device. The SSID and password are displayed on the connection waiting screen of this camera <ul style="list-style-type: none"> Ⓐ SSID and Password <ul style="list-style-type: none"> When [Wi-Fi Password] is set to [OFF], the password is not displayed. Select SSID to connect. (→232)



- Read the instructions of your device for details.

Connecting quickly with the same settings as used previously ([Select a destination from History] / [Select a destination from Favorite])

The camera keeps a history of times you used the Wi-Fi function. You can register items in the history to Favorite.

You can easily connect with the same settings as used previously by connecting from the history or Favorite.

- If the Wi-Fi settings of the device to connect to have been changed, it may not be possible to connect to the device.

1 Set the menu

MENU →  [Setup] → [Wi-Fi] → [Wi-Fi Function]

[Select a destination from History]	Connects using the same settings as used previously.
-------------------------------------	--

[Select a destination from Favorite]	Connects using settings registered in Favorite.
--------------------------------------	---

2 Select the desired connection setting

- When selecting history or Favorite items, you can view connection details by pressing [DISP].

Registering History items to Favorite

MENU →  [Setup] → [Wi-Fi] → [Wi-Fi Function]
→ [Select a destination from History]

1 Select the item you wish to register and press ►

2 Enter a registration name

- For details on how to enter characters, refer to "Entering Text" (→50)
- Up to 30 characters can be entered. A double-byte character will be treated as two characters.

Editing items registered in Favorite

MENU →  **[Setup]** → **[Wi-Fi]** → **[Wi-Fi Function]**
→ **[Select a destination from Favorite]**

1 Select the Favorite item you wish to edit and press ►

[Remove from Favorite]	—
[Change the Order in Favorite]	For selecting the destination.
[Change the Registered Name]	• For details on how to enter characters, refer to “Entering Text” (→50)

- The number of settings that can be saved in the history is limited. Register and save frequently used Wi-Fi connection settings to Favorites.
- Performing [Reset Wi-Fi Settings] deletes content registered in the history and Favorite.
- If the device you want to connect to (smartphone, etc.) is connected to a wireless access point other than the camera, you cannot connect the device to the camera using [Direct]. Change the Wi-Fi settings of the device you want to connect to so that the access point to be used is set to the camera.
You can also select [New Connection] and reconnect the devices. (→249)

[Wi-Fi Setup]

Configure the settings required for the Wi-Fi function.
[Wi-Fi Setup] cannot be changed when connected to Wi-Fi.

MENU →  **[Setup]** → **[Wi-Fi]** → **[Wi-Fi Setup]**

[Priority of Remote Device]	(→236)
[Wi-Fi Password] You can improve security by enabling password entry for a direct connection to a smartphone.	[ON]: Connects the camera and a smartphone using an SSID and password. (→230) [OFF]: Connects the camera and a smartphone using an SSID. (→230) <hr/> <ul style="list-style-type: none"> • When [ON] is selected, you can also set up a connection by scanning a QR code.
[Device Name] You can change the name (SSID) of this camera.	<ol style="list-style-type: none"> ① Press [DISP] ② Enter the desired device name (Up to 32 characters can be entered) <ul style="list-style-type: none"> • For details on how to enter characters, refer to "Entering Text" (→50)
[Wi-Fi Function Lock] To prevent incorrect operation or use of the Wi-Fi function by a third party and to protect saved personal information, it is recommended that you protect the Wi-Fi function with a password.	[Setup]: Enter any 4-digit numbers as the password. [Cancel] <hr/> <ul style="list-style-type: none"> • For details on how to enter characters, refer to "Entering Text" (→50) • If you forget the password, you can reset it with [Reset Network Settings] (→205) in the [Setup] menu.
[Network Address] Displays the MAC address and IP address of this camera.	<ul style="list-style-type: none"> • A "MAC Address" is a unique address that is used to identify network equipment. • "IP address" refers to a number that identifies a PC connected to a network such as the Internet. Usually, the addresses for homes are automatically assigned by the DHCP function such as a wireless access point. (Example: 192.168.0.87)
[Approved Regulations] Displays certification note.	The technical compliance standard authentication number is displayed.

Viewing 4K videos

■ Viewing on a TV

When you connect the camera to a 4K-compatible TV and play back a video recorded with [Rec Quality] of [4K], you can enjoy high-resolution 4K images. Although resolution output will be lower, you can also play back 4K videos by connecting to a high-definition TV and other devices that do not have 4K support.

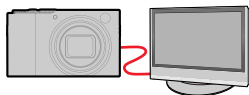

Preparations

- Set [HDMI Mode (Play)] (→202) to [AUTO] or [4K/30p].
- When connecting to a TV that does not support 4K, select [Auto].

① Connect the camera to a 4K-compatible TV using an HDMI micro cable and display the playback screen (→258)

- When the [HDTV Link] setting on the camera is set to [ON] and the camera is connected to a HDTV Link (HDMI)-compatible TV, it automatically switches its input and the playback screen is displayed. For details, refer to (→261).
- You can also play back 4K videos by inserting the card into the SD card slot of a TV that supports 4K.
- Read the instructions for the TV.

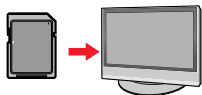

■ Viewing 4K videos on a PC screen

- To play back and edit 4K videos, a high-performance PC environment is required.



Saving 4K videos

You can only dub 4K videos to a Blu-ray disc or DVD with the specific compatibility.

■ Storing 4K videos on your PC

You can use the software available for downloading after registering your camera on the Leica Camera AG homepage to import 4K videos to a PC. (→262)

- For details, refer to the software instructions.

Viewing on a TV

Preparation

Turn off both camera and TV.

1 Connect the camera to the TV

Check the plug orientation and insert it straight. (If the cable is inserted in the wrong direction, the plug and socket terminals could become deformed and cause faulty operation.) Also, do not insert into the wrong socket. Doing so may damage the camera.

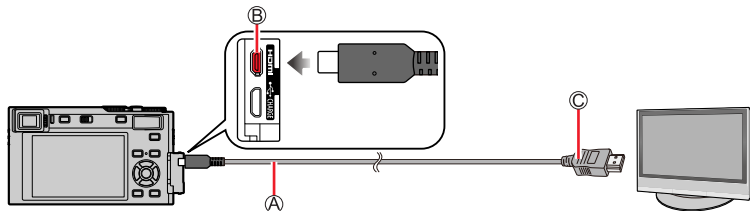

Ⓐ HDMI micro cable

Use a "High Speed HDMI micro cable" with the HDMI logo.

Cables that do not comply with the HDMI standards will not work.

"High Speed HDMI micro cable" (Type D - Type A plug, up to 2 m (7") long)

Ⓑ [HDMI] socket

Ⓒ To HDMI video/audio input socket

2 Turn on the TV and switch its input source to match the connection socket

3 Turn on the camera and press [▶]

Viewing on a TV

- Bars may appear at the sides or at the top and bottom of the screen, depending on the aspect ratio setting.
- Change the screen mode on your TV if the picture is displayed with the top or bottom cut off.
- Depending on the TV to be connected, video or 4K picture series files may not be played back correctly.
- Check the [HDMI Mode (Play)]. (→202)
- To play back 24p videos, set [HDMI Mode] to [AUTO]. Otherwise, the picture is not output at 24 frames per second.
- During TV viewing, pictures are not displayed on the camera screen. Also, sound is not produced from the camera's speaker.
- HDMI output will be canceled if a USB cable is connected simultaneously.
- Read the instructions for the TV.

**The recorded pictures can be played back on a TV with an SD Memory Card slot**

- Proper playback (aspect ratio) will be dependent on the TV used for viewing.
- Video file formats that can be played back differ depending on the TV model.
- You may not be able to play back panorama pictures. Also you cannot perform automatic scrolling playback of panorama pictures.
- For cards compatible with playback, refer to the instructions of the TV.

Recording while monitoring camera images

When using the HDMI output, you can take pictures while monitoring the camera image on a TV, etc.

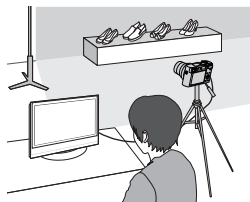

Switching the information displayed

You can change the display shown during HDMI output using [HDMI Info Display (Rec)] in [TV Connection] on the [Setup] menu.

[ON]: The camera display is output as is.

[OFF]: Only images are output.

- When using the Autofocus Mode [\square] or MF assist, the screen cannot be enlarged in windowed mode.
- If you use the HDMI output during recording, the aspect ratio setting is fixed to [16:9].
- An electronic sound or shutter sound will not sound.
- Some of setting screens are not output through the HDMI connection.
- This function is not available in the following cases:
 - During video recording
 - During panorama picture recording
 - When recording 4K photos
 - When recording using [Post Focus]

HDTV Link (HDMI) (HDAVI Control™)

What is HDTV Link (HDMI)?

- HDTV Link is a function that automatically links this camera to HDTV compatible devices via HDMI micro cables for enabling easy operation with the HDTV remote control. (Some operations are not available.)
- HDTV Link (HDMI) is an exclusive function added to the industry-standard HDMI control functions known as HDMI CEC (Consumer Electronics Control). Operation is not guaranteed when connecting with other HDMI CEC-compatible devices. Refer to your product's instructions to verify compatibility with HDTV Link (HDMI).

Preparation

Set [HDTV Link] to [ON] (→202).

- 1 Connect the camera to an HDTV Link (HDMI)-compatible TV with an HDMI micro cable (→258)**
- 2 Turn on the camera and press [▶]**
- 3 Operate with the remote control for the TV**

Turning the camera off

- The camera can also be turned off when the television is turned off with its remote control.

Automatic input select

- When the camera and TV are connected by HDMI micro cable, the camera is turned on, and the camera's [▶] (Playback) button is pressed, the television input automatically switches to the camera's screen. The television can also be switched on via the camera from Standby Mode (if "Power on link" on the TV is set to "on", provided, it has this function).

- Operations via the camera buttons will be limited.
- To play back the audio of the videos in a slide show, set the [Sound] in the Slide Show setting screen to [AUTO] or [Audio].
- Use a "High Speed HDMI micro cable" with the HDMI logo.
Cables that do not comply with the HDMI standards will not work.
"High Speed HDMI micro cable" (Type D - Type A plug, up to 2 m (7") long)
Compatible HDMI micro cables are available from specialist photo dealers. Make absolutely sure to use only cables compatible with this camera.
- If HDTV Link (HDMI) does not function correctly (→283)

Copying the Recorded Image Data to a Computer

With card readers (external)

- Some computers can read directly from the card taken from the camera, others require the use of an external card reader. For details, refer to the instructions of the respective devices.
- If the computer being used does not support SDXC Memory Cards, a message prompting you to format may appear. (Doing so would cause all recorded image data to be erased, so make sure to select [NO].)
- With an external card reader, make sure it supports the type of card being used.

With a computer connected directly to the camera (using the available software)

■ Computers that can be used:

Any model capable of recognizing a mass storage device.

- Windows support: Windows 7/Windows 8/ Windows 8.1/Windows 10
- Mac support: OS X v10.5 to macOS 10.13

Using the software available for downloading after registering your camera on the Leica Camera AG homepage, you can import the image data for pictures and videos recorded with this camera in all file formats to a computer.

■ Installing the software

To utilize the software, it must be installed first. Three preparatory steps are necessary:

① Register your camera on the Leica Camera AG homepage.

- Open an account at <http://owners.leica-camera.com>. As a result, you will receive access to the "Owners area".
- Register your camera at "My products" by entering its serial number. Do so by following the respective instructions.
- Then select "...software download...". You will be requested to enter the TAN code which you will find on a sticker on the Guarantee card.
 - The key with which you can activate the software will be sent to you by email.

② Install the software to your computer.

③ Activate the software with the key (numbers) you have received.

- Do so by following the respective instructions appearing after opening the software.
- For details on how to operate the software, refer to the online assistance.

Copying the Recorded Image Data to a Computer

Copying pictures and videos

Preparations

- Turn on the camera and computer.

1 Connect the camera to the computer

- Check the plug orientation and insert it straight. (If the plug is inserted in the wrong direction, the plug and socket terminals could become deformed and cause faulty operation.) Also, do not insert into the wrong socket. Doing so may damage the camera.
- Do not use any other USB cables except a genuine Leica USB cable of the supplied type. Using cables other than the above may cause a malfunction.

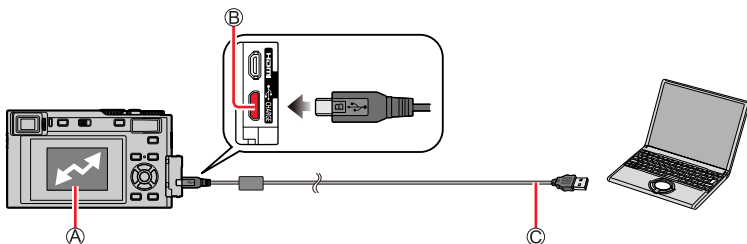

(A) [Access]

- Do not disconnect the USB cable while [Access] is displayed.

(B) [USB/CHARGE] socket

(C) USB cable

2 Use **▼** to select [PC(Storage)] and press [MENU/SET]

- If you set the [USB Mode] to [PC(Storage)] in the [Setup] menu in advance, the camera will be automatically connected to the PC without displaying the [USB Mode] selection screen.

3 Copy the images to the computer using the software available for downloading after registering your camera on the Leica Camera AG homepage

- Before inserting or removing a card, turn the camera off and disconnect the USB cable. Otherwise, data may be destroyed.
- Use a sufficiently charged battery.
- When the battery begins to run out during communication, a warning beep sounds. Remove the USB cable safely. Otherwise, data may be destroyed.

Copying the Recorded Image Data to a Computer

■ Copying to your computer without using software

You can save pictures to use on your computer by dragging and dropping folders and files into separate folders on your computer.

• **Cards used in this camera contain the following files (folder structure).**

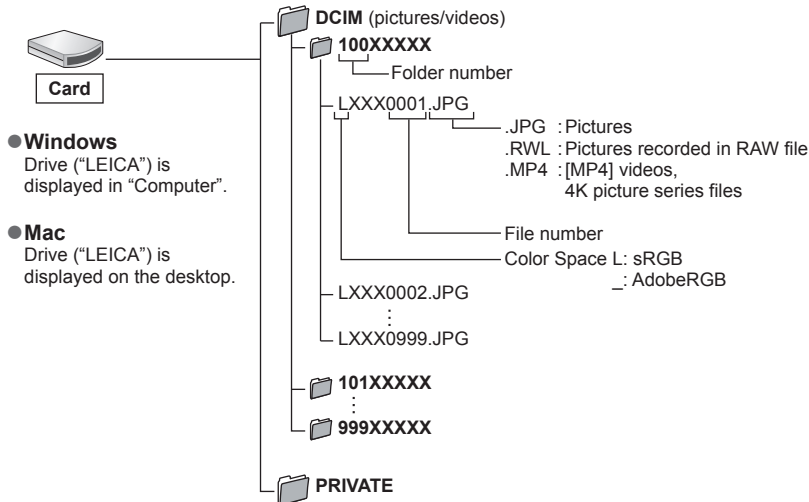

Storing recorded pictures and videos in a recorder

If you insert a card that has pictures recorded with this camera into an accordingly equipped recorder, you can dub the content to a Blu-ray Disc or DVD etc.

- See the instructions for the recorder for details for copying and playing back.

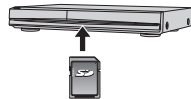

Printing

You can connect a camera directly to a PictBridge-compatible printer for printing.

Preparations

- Adjust the print quality or other settings on your printer, as needed.
- Turn on camera and printer.

1 Connect the camera to the printer

- Check the plug orientation and insert it straight. (If the plug is inserted in the wrong direction, the plug and socket terminals could become deformed and cause faulty operation.) Also, do not insert into the wrong socket. Doing so may damage the camera.
- Do not use any other USB cables except a genuine Leica USB cable of the supplied type. Using cables other than the above may cause a malfunction.

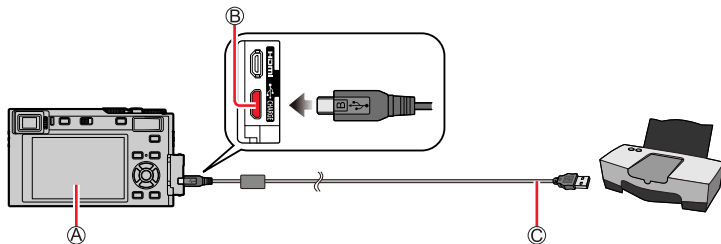

A [🚫]

- Do not disconnect the USB cable when the cable disconnection icon [🚫] is displayed (may not be displayed with some printers).

B [USB/CHARGE] socket

C USB cable

2 Use ▲ to select [PictBridge(PTP)] and press [MENU/SET]

3 Use ◀▶ to select a picture and press [MENU/SET]

4 Use ▲ to select [Print start] and press [MENU/SET]

Printing multiple pictures

Multiple pictures can be printed at one time.

1 Press ▲ to select [Multi Print] in step 3 of “Printing” (→266)

2 Use ▲ ▼ to select the item and press [MENU/SET]

[Multi Select]	① Scrolls between pictures with ▲ ▼ ◀ ▶, select pictures to print with [MENU/SET] (Press [MENU/SET] again to release selection.) ② Press [DISP] to execute
[Select All]	Prints all pictures.
[Rating]	Prints pictures selected as [Rating].

3 Use ▲ to select [Print start] and press [MENU/SET]

- The group pictures are displayed one by one instead of all at the same time.
- Use a sufficiently charged battery. When the battery begins to run out during communication, a warning beep sounds. Cancel printing and disconnect USB cable.
- Before inserting or removing a card, turn the camera off and disconnect the USB cable.
- Some printers can print directly from the camera's memory card. For details, see the instructions for your printer.
- A yellow “●” displayed during printing indicates an error message.
- Print may be divided into several pictures if printing a large amount of pictures. (Remaining sheets display may differ from the number of pictures set for printing.)
- Videos, 4K picture series files, and pictures recorded with [Post Focus] cannot be printed.
- Pictures recorded in a RAW file cannot be printed. (The pictures recorded in JPEG file format at the same time as the RAW file can be printed.)

■ Making print settings on the camera

Setting options include the number of printed pictures and their size. Make settings before selecting [Print start].

[Print with Date]	[ON] / [OFF]
[Num.of prints]	Sets number of pictures (up to 999 pictures).
[Paper Size]	Sets the paper size.
[Page Layout]	Sets whether or not to add borders and how many pictures to be printed on each sheet of paper.

- If the printer does not support date printing, the date cannot be printed on the picture.
- When setting [Print with Date] to [ON], check the date printing settings on the printer (printer settings may be prioritized).
- Items may not be displayed if incompatible with printer.
- To print to paper sizes/layouts not supported by this camera, set to [🔒] and make settings on the printer. (Consult your printer's instructions.)

■ Printing with date and text

Time and date can be set to be printed on the picture when taking the picture by activating the [Text Stamp] function in the [Playback] menu. (→218)

■ Printing date without [Text Stamp]

Printing in store:

Only the recording date can be printed. Request date printing in the store.

- The characters entered for [Age] or [Name] of [Profile Setup] or [Face Recog.], [Location] in [Travel Date], and [Title Edit] cannot be printed at a store.

Using a printer:

The recording date can be printed by setting [Print with Date] (→268) to [ON] when connecting to a printer compatible with date printing.

List of monitor/viewfinder displays

- The following images are examples of when [Monitor Disp. Set] is set to [] (monitor style) in the monitor.
- The information displayed, such as histograms, magnifications, and numeric values, are only for the purpose of reference.



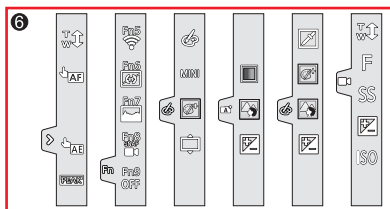
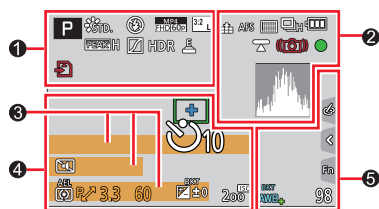























In recording



	Recording mode (→34)
	Custom Set (→81)
	[Photo Style] (→168)
	Flash setting (→144, 147)
	[Rec Quality] (→150)
	[Snap Movie] (→153)
	[Aspect Ratio] (→166)/ [Picture Size] (→166)
	Image size (Panorama Shot Mode) (→64)
	Picture effect (Filter) adjustment display (→72, 170)
	Types of picture effects (Filter) (→170)
	Card (displayed only during recording) (→25)

	Elapsed recording time*1 (→148)
	Simultaneous recording indicator (→152)
	Automatic switching between viewfinder and monitor (→31)
	[Peaking] (→188)
	[Highlight Shadow] (→173)
	[HDR] (→178)/ [iHDR] (→54)
	[Multi Exp.] (→179)
	Electronic shutter (→177)
	Overheat indicator (→279)

List of monitor/viewfinder displays

2	 RAW	[Quality] (→167)	3	Name*² (→195)
	120fps	[High Speed Video] (→78)		Travel elapsed days*³ (→197)
	AFS AFF AFC MF	[AFS/AFF/AFC] (→84)/ MF (→97)		Age in years/months*² (→195)
	BKT AFS	Focus Bracket (→130)		Location*³ (→197)
		[AF Mode] (→85)		Current date/time*³
		[Pull Focus] (→155)		Travel destination setting*³ :  (→196)
		[Face Recog.] (→192)		Exposure meter (→191)
	AFL	AF Lock (→99)		Zoom (→141)
		Burst (→125)	4	 AF area (→91)
		[4K PHOTO] (→108)		+ Spot metering target (→172)
		[Post Focus] (→119)		+ [Center Marker] (→189)
		[Self Timer] (→127)		 [Self Timer] (→127)
		Remaining battery (→22)		 [Zoom Mic] (→181)
	AF 	Macro recording (→96)		 [Silent Mode] (→176)
		[Level Shot] (→180)		AEL AE Lock (→99)
		[Stabilizer] (→137)		 [Metering Mode] (→41, 172)
		Camera shake alert (→137)		P  Program Shift (→56)
		Focus (Lights green.) (→33)/ Recording state (Flashes red.) (→148)		3.3 Aperture value (→33)
		Focus (Under low illumination) (→83)		BKT 3.3 Aperture Bracket (→130)
		Focus (Starlight AF) (→83)		60 Shutter speed (→33)
		Wi-Fi connection status		Exposure compensation (→100)
		Bluetooth connection status (→230)		Exposure Bracket (→129)
	GPS	Location Logging (→243)		 Brightness (exposure) (→55, 76)
		Histogram (→189)		Manual Exposure Assist (→59)
				ISO 200 ISO sensitivity (→101)

List of monitor/viewfinder displays

5		
	[Dial Guide] (→187)	
	White Balance (→103)	
	White Balance Bracket (→107)	
	White Balance Fine Adjustment (→106)	
	Coloring (→54)	
98	Number of recordable pictures (→26)	
r20	Maximum number of pictures that can be taken continuously (→125)	
RXXmXXs	Available recording time*1 (→27)	

6		
	Touch tab (→186)	
	Touch zoom (→142)	
	Touch Shutter (→40)	
	Touch AF (→40)	
	[Touch AE] (→41)	
	[Peaking] (→188)	
	Function buttons (→47)	

	Coloring (→55)	
	Defocus control function (→55, 76)	
	Brightness (exposure) (→55, 76)	
	Type of defocus ([Miniature Effect]) (→74)	
	[One Point Color] (→75)	
	[Sunshine] (→75)	
	Picture effect (Filter) adjustment display (→72, 170)	(→55) (→76) (→77)
	Picture effects ON or OFF (→170)	
MINI	Picture effects (Filter) (→170)	
F	Aperture value (→77)	
SS	Shutter speed (→77)	
ISO	ISO sensitivity (→77)	

*1 [m] and [s] indicate “minute” and “second”.

*2 This is displayed for about 5 seconds when the camera is turned on if the [Profile Setup] setting is set.

*3 This is displayed for about 5 seconds when the camera is turned on, after setting the clock and after switching from Playback to Recording mode.

List of monitor/viewfinder displays

In playback











1

	Playback Mode (→209)
	Protected picture (→210)
GPS	With location information (→243)
	[Rating] (→210)
	Cable disconnect prohibit icon (→266)
	Video playback (→157)
	Panorama picture playback (→66)
	Continuous playback of picture group (→161)
	Save pictures from the 4K picture series file (→111)
	Save a picture from pictures recorded using [Post Focus] (→121)
	Group pictures recorded using Focus Bracketing (→161)
	Text stamped display (→218)
XXmXXs	Elapsed playback time *1

2

	Icon indicating the presence of a marker (→112, 113)
	4K Photo (4K picture series file) (→108)
	[Post Focus] (→119)
	[Focus Stacking] (→122)
	[Aspect Ratio] (→166)/ [Picture Size] (→166)
	[Rec Quality] (→150)
	[Snap Movie] (→153)
	[Quality] (→167)
120fps	[High Speed Video] (→78)
	Remaining battery (→22)
1/98	Picture number/Total pictures
	Wi-Fi connection status
15 pic.	Number of group pictures
XXmXXs	Video recording time *1 (→157)

List of monitor/viewfinder displays

③	 Clear Retouch completed icon (→217)	④	Name *2 (→193, 195)
	Acquiring information icon		Location *2 (→197)
	Playback (Videos) (→157)		Title *2 (→211)
 1ST DAY	Travel elapsed days (→197)		Age in years/months (→193, 195)
	Picture Group Display (→162)	⑤	Recording information
	[Silent Mode] (→176)		
	Multi Playback (→159)		
	Delete (→163)		

*1 [m] and [s] indicate "minute" and "second".

*2 It is displayed in order of [Title], [Location], [Name] ([Baby1]/[Baby2], [Pet]), [Name] ([Face Recog.]).

List of monitor/viewfinder displays

Detailed information display

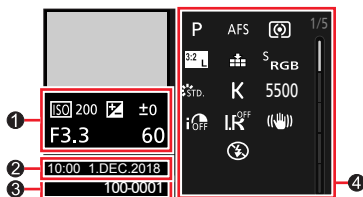

Histogram display

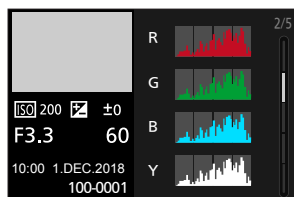
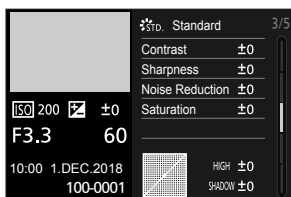
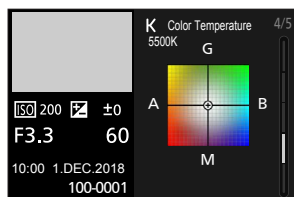

Photo style, Highlight shadow display



White balance display



Lens information display

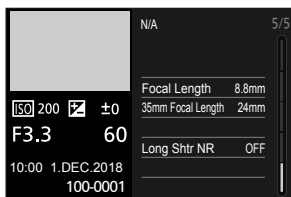

①

Recording information (Basic)

②

Recording date/time
World time (→196)

③

100-0001 Folder/File number (→264)

④

Recording information (Advanced)

5500 White Balance (color
temperature) (→104)

i OFF [i.Dynamic] (→174)

HDR ON [HDR] (→178)/[iHDR] (→54)

i.R OFF [i.Resolution] (→174)

Message displays

The following explains the meaning of major messages displayed on the screen, and how to respond to them.

■ Memory cards

[Memory Card Error] / [Format this card?]

- Save needed data on a computer or other device, and then use [Format] on the camera. (→26)
- Try with a different card.

[Read Error] / [Write Error] / [Please check the card]

- Check whether the card has been inserted correctly (→24).
- Turn off the camera and remove the card. Reinsert the card and turn the camera on again.
- Try with a different card.

[Recording was cancelled due to the limitation of the writing speed of the card]

- The speed class of a required card varies depending on a video's [Rec Quality]. 4K photo recording requires a card that meets a particular speed class rating. Use a card that meets the rating. Be sure to use a card of the recommended speed class (→25).
- If recording stops even when using a card of the recommended speed class (→25), the data writing speed has dropped. If this happens, we recommend backing up the data on the card and formatting it (→26). Depending on the type of the card, recording may stop in the middle.

[Memory Card Error] / [This memory card cannot be used]

- Use a compatible card. (→25)

■ Battery

[This battery cannot be used]

- Use a genuine Leica battery. Consult your dealer or your nearest Leica Customer Care center if the display still remains.
- Wipe any dirt away from the battery terminals.

■ Wi-Fi function

[Failed to connect wireless access point] / [Connection failed] / [No destination found]

- The wireless access point information set on this camera is wrong. Check the authentication type, encryption type, and encryption key. (→250)
- Transmissions from other devices may block the connection to a wireless access point. Check other devices that are connected to the wireless access point and devices that use the 2.4 GHz band.

[Connection failed. Please retry in a few minutes.] / [Network disconnected. Transfer stopped.]

- The transmission from the wireless access point is getting weak. Perform the connection closer to the wireless access point.
- Depending on the wireless access point, the connection may be automatically disconnected after a specific time has passed. Reconnect.

[Connection failed]

- Change the access point to connect to in the smartphone Wi-Fi settings to this camera.

■ Others

[Some pictures cannot be deleted] / [This picture cannot be deleted]

- Non-DCF pictures (→156) cannot be deleted. Save needed data on a computer or other device, and then use [Format] on the camera. (→26)

[Cannot be set on this picture]

- [Title Edit], [Text Stamp], and other functions cannot be used for pictures that are not compliant with the DCF standard (→156).

[A folder cannot be created]

- A folder cannot be created because available folder numbers have been already assigned. Save all necessary pictures to your computer or other devices and format the card (→26). After you format the card, execute [No.Reset] in the [Setup] menu to reset the folder number to 100. (→205)

[Please turn camera off and then on again] / [System Error]

- Turn the camera on again. (Consult your dealer or your nearest Leica Customer Care center if the display still remains.)

Q&A Troubleshooting

① Try checking these items (→277 - 284) first.

If the problem persists,

② Performing [Reset] in the [Setup] menu may resolve the issue (→205).

■ Battery, power

The charging lamp flashes.

- Charging is being performed in a place with extremely high or low temperatures.
→ Reconnect the USB cable and retry charging in a place where the ambient temperature is 10 °C to 30 °C (50 °F to 86 °F) (temperature conditions also apply to the battery itself).
- Charging is not possible if the power supply capacity of the computer is low.

Camera does not work even if the camera is turned on. Camera switches off as soon as the camera is turned on.

- The battery needs recharging.
→ Charge the battery. (→18)

This camera is turned off automatically.

- [Economy] is activated. (→199)

The battery runs down quickly.

- [4K PHOTO] is set to [4K Pre-Burst].
→ When [4K Pre-Burst] has been selected, the battery drains faster.
Select [4K Pre-Burst] only when recording.
- The Wi-Fi connection has been on for a long time.
→ The battery is used up faster with a Wi-Fi connection. Turn off the camera as often as possible using [Economy] (→199) or other methods.

■ Recording

Striping or flicker may appear under lighting such as fluorescent lighting and LED lighting fixture.

- This is characteristic of MOS-type sensors like the one in this camera. This is not a malfunction.
- If you are taking pictures using the electronic shutter, the striping may be reduced by setting a slower shutter speed. (→58)
- When noticeable flicker or striping is seen under lighting such as a fluorescent or LED lighting fixture in video recording mode, you can reduce it by setting up [Flkr Decrease] (→180) and fixing the shutter speed. It is possible to select a shutter speed from [1/50], [1/60], [1/100], or [1/120]. You can set the shutter speed manually in the Creative Video Mode. (→77)

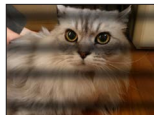

Cannot record pictures. The shutter will not operate immediately when the shutter button is pressed.

- When [Focus/Release Priority] is set to [FOCUS], the camera will not record until proper focusing is achieved. (→185)

Recorded pictures look white.

- Lens is dirty (fingerprints, etc.).
→ Turn the camera on to extract the lens barrel, and clean the front lens surface with a soft, dry cloth.

Recorded pictures are too bright/too dark.

- AE Lock (→99) is set inappropriately.

Some pictures are taken when I press the shutter button just once.

- Drive Mode is set to other than [Single]. (→124)
- Bracket recording is set. (→128)

Correct focusing is not achieved.

- The subject is outside the focusing range.
- [Focus/Release Priority] is set to [RELEASE]. (→185)
- [Shutter AF] is set to [OFF]. (→183)
- AF Lock (→99) is set inappropriately.
- If there are fingerprints or dirt on the front lens surface, the focus may not be set on the subject.

Recorded pictures are blurred. The stabilizer function ineffective.

- The shutter speed is slower in dark locations and the stabilizer function is less effective.
→ Use a tripod and the self-timer (→127) when using a slower shutter speed.

Recorded pictures appear 'grainy', or there is interference.

- We recommend trying the following methods.
 - Use a lower ISO sensitivity (→101).
 - Either adjust [Noise Reduction] of [Photo Style] to a higher setting or set each item other than [Noise Reduction] to a lower setting. (→169)
 - Set [Long Shtr NR] to [ON]. (→175)

The subject appears skewed in pictures.

- If you take a picture of a moving subject in the electronic shutter mode, video recording mode, or 4K photo recording mode, the subject in the picture may be skewed in some cases. This is characteristic of MOS-type sensors like the one in this camera. This is not a malfunction.

Brightness or coloring of the recorded picture are different from real life.

- When recording under fluorescent or LED lighting fixture etc., increasing the shutter speed may introduce slight changes to brightness and color. These are a result of the characteristics of the light source and do not indicate a malfunction.
- When recording subjects in extremely bright locations or recording under fluorescent lighting, LED lighting fixture, mercury lamp, sodium lighting etc., the colors and screen brightness may change or horizontal striping may appear on the screen.

4K photo recording stops before finishing.

- When the ambient temperature is high or recording of the 4K Photo function is performed continuously, the camera may display [,] and stop the recording. Wait until the camera cools down.

■ Videos

Videos cannot be recorded.

- When a large capacity card is used, you may not be able to take a picture for a while after you turn on the camera.

Video recording stops midway.

- When the ambient temperature is high or a video is recorded continuously, the camera may display [>] and stop the recording. Wait until the camera cools down.
- The required speed class of a card varies depending on the video [Rec Quality]. Be sure to use a card of the recommended speed class (→25).

Sometimes focusing with Autofocus mode is difficult while recording 4K videos.

- This may occur when taking a picture by reducing the Autofocus speed in order to adjust the focus at high precision. This is not a malfunction.

A noise, such as a clicking or buzzing noise, is recorded on a video. Audio is recorded at low volumes.

- With recording in a quiet environment, the sound of aperture, focus and other actions may be recorded in videos. This is not a malfunction. Focusing during video recording can be set to [OFF] in [Continuous AF] (→151).
- If you block the microphone with your fingers while a video is being recorded, the audio may be recorded at a low volume or may not be recorded at all. In this case, the camera may pick up the lens operating sounds more easily.

Operating sounds are recorded in a video.

- We recommend recording videos in Creative Video Mode if you are concerned about operating noise. (→77)

■ Flash

No flash is emitted.

- The flash function is unavailable in the following cases.
 - The flash is closed.
 - The flash mode is set to [>] (Forced Flash Off). (→143, 145)
- Set [Shutter Type] to [AUTO] or [MSHTR]. (→177)
- Set [Silent Mode] to [OFF]. (→176)

■ Monitor/viewfinder

The monitor/viewfinder is turned off although the camera is turned on.

- If no operations are performed during the set time period [Auto EVF/Monitor Off] (→199) is activated, and the monitor/viewfinder turns off.
- When a hand or an object is close to the eye sensor, the monitor display mode could be switched to viewfinder display mode. (→31)

The monitor/viewfinder image may flicker for an instant or the brightness of the screen may change significantly for an instant.

- This occurs due to the aperture of the lens changing when the shutter button is pressed halfway, or when the brightness of the subject changes. This is not a malfunction.

Pressing [EVF] does not switch between the monitor and viewfinder.



- When it is connected to a computer or printer, the camera can display pictures on the monitor only.

■ Playback

Pictures cannot be viewed. There are no recorded pictures.

- A card is not inserted in the camera.
- Has the file name of the picture been changed on a computer? If so, it cannot be played back on the camera.
→ It is recommended to use the software available for downloading after registering your camera on the Leica Camera AG homepage (→262) to write pictures from PC to card.
- Set [Playback Mode] to [Normal Play]. (→209)

Red areas in pictures appear blackened.

- When the digital red-eye correction ([, [) is operating, red areas may be blackened.
→ We recommend closing the built-in flash, setting the flash mode to [, or setting [Red-Eye Removal] to [OFF] before recording. (→174)

■ Wi-Fi function

A Wi-Fi connection cannot be established. The transmission gets disconnected. A wireless access point is not displayed.

General tips for using a Wi-Fi connection

- Use within the communication range of the wireless LAN network.
- Is any device, such as a microwave oven, a cordless phone, etc., that uses 2.4 GHz frequency operated nearby?
 - The transmission may get interrupted when used simultaneously. Use them sufficiently far away from the device.
- When the battery indicator is flashing red, the connection with other equipment may not start or the connection may be disrupted. (A message such as [Communication error] is displayed.)
- When this camera is placed on a metal table or shelf, the connection may not be established easily. Use the camera away from metal surfaces.

About a wireless access point

- Check if the wireless access point to connect is in its operating state.
- Check the transmission condition of the wireless access point.
 - Perform the connection closer to the wireless access point.
 - Move the wireless access point or change its angle.
- Even if a transmission exists, it may not be displayed depending on the setting of the wireless access point.
 - Turn off the wireless access point and then turn it back on.
- Is the network SSID of the wireless access point set not to broadcast?
 - It may not be detected when it is set not to broadcast. Enter and set the network SSID. (→250)
Alternatively, set the network SSID of the wireless access point to broadcast.

The camera is not displayed in the Wi-Fi setting screen of the smartphone.

- Try switching the Wi-Fi function off and back on in the Wi-Fi settings of the smartphone.

Transmission of the image fails midway. There is an image that could not be transmitted.

- Is the size of the image too large?
 - Transmit after dividing the video with [Video Divide] (→221).
 - Reduce the resolution at [Size] (→248), and then send.
- It may take longer to transmit when the distance to the wireless access point is greater.
 - Transmit closer to the wireless access point.
- File formats of the picture that can be sent. (→245)

I have forgotten the password for the Wi-Fi.

- Execute the [Reset Network Settings] in the [Setup] menu. (→205)
However, the information you have set on the [Wi-Fi Setup] or [Bluetooth] will be reset.

■ TV, computer, printer**No image appears on the TV. The image is blurred or not colored.**

- The connection is not correct (→258).
- The television has not been switched to auxiliary input.

HDTV Link (HDMI) is not working.

- Is the camera's [HDTV Link] setting set to [ON]? (→202)
→ Check the HDTV Link (HDMI) settings on the device you are connecting to.
→ Turn the camera off and on again.

Communication with the computer is not possible.

- Set [USB Mode] to [PC(Storage)] (→201, 263).
- Turn the camera off and then on again.

The computer does not recognize the card. (When using an SDXC Memory Card)

- Check whether your computer is compatible with SDXC Memory Cards.
- A message prompting you to format the card may appear when you connect it. Do not format the card.
- If the [Access] indicator on the screen does not go off, turn the camera off before disconnecting the USB cable.

Printing is not possible even though camera and printer are connected properly.

- The printer is not compatible with PictBridge.
- Set [USB Mode] to [PictBridge(PTP)] (→201, 266).

The edges of pictures are cut off when printing.

- Release any trimming or edgeless printing settings on printer before printing.
- The aspect ratio of pictures is different from that of paper used for printing.
→ If printing in shop, check if 16:9 sizes can be printed.

■ Others**The lens makes a clicking noise.**

- When the camera is turned on or off, the lens is moved, or an aperture setting is changed, such a noise may be heard. This is not a malfunction.
- When the brightness changes after changing the zoom lens' focal length or moving the camera, the lens may make a noise while adjusting the aperture. This is not a malfunction.

Zooming stops instantaneously.

- When using Extended optical zoom, the zooming action will stop temporarily. This is not a malfunction.

The red lamp is illuminated when pressing the shutter button halfway in dark locations.

- [AF Assist Lamp] is set to [ON] (→184).

The camera is hot.

- The camera may become a little warm during use, but this does not affect performance or quality.

The clock's setting is incorrect.

- If you do not use the camera for a long time, the clock may have to be reset.
→ Reset the clock (→29).

Usage cautions and notes

When in use

- **Keep this camera as far away as possible from electromagnetic equipment (such as microwave ovens, TVs, video games etc.).**
 - If you use this camera on top of or near a TV, its pictures and/or sound may be disrupted by electromagnetic fields.
 - Do not use this camera near cell phones because doing so may result in noise adversely affecting the pictures and/or sound.
 - Recorded data may be damaged, or pictures may be distorted, by strong magnetic fields created by speakers or large motors.
 - Electromagnetic fields may adversely affect this camera, disturbing the pictures and/or sound.
 - If the camera is adversely affected by electromagnetic equipment and stops functioning properly, turn it off and remove the battery. Then reinsert the battery and turn the camera back on.
- **Do not use this camera near radio transmitters or high-voltage lines.**
 - If you record near radio transmitters or high-voltage lines, the recorded pictures and/or sound may be adversely affected.
- Do not extend the supplied cords or cables.
- Do not allow the camera to come into contact with pesticides or volatile substances (this can cause surface damage or the coating to peel).
- Do not keep objects that may be influenced magnetically close to the speaker.
 - Magnetized objects such as bank cards, commuter passes, and watches may be adversely affected by the magnetic influence of the speaker.
- Never leave the camera and the battery in a car or on a car hood in the summer. Doing so may cause leakage of the battery electrolyte, overheating, fire or a battery explosion due to the high temperature.

Caring for your camera

To clean your camera, remove the battery, and/or disconnect the power plug from the outlet, and wipe with a soft, dry cloth.

- Use a damp cloth to remove stubborn stains, before wiping with a dry cloth.
- Do not use benzine, thinners, alcohol, or kitchen detergent, as these may damage the outer casing and finish of the camera.
- If using a chemically-treated cloth, read the supplied instructions carefully.
- Do not touch the lens shutter.

Ⓐ Lens shutter

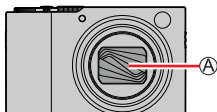

When not using for a while

- Turn off the camera before removing the battery and the card.
 - Ensure that the battery is removed to prevent damage through over-discharge.
 - Clock settings will be saved for approx. 3 months even after the battery is removed, provided a fully charged battery was installed in the camera for 24 hours beforehand.
- Do not leave the camera in contact with rubber or plastic bags.
- Store the camera together with a drying agent (silica gel) if leaving in a drawer, etc. Store batteries in cool (15 °C to 25 °C (59 °F to 77 °F)) places with low humidity (40%RH to 60%RH) and no major temperature changes.
- Charge the battery once per year and use completely before storing again.
- Check all the parts before taking pictures when you have not used the camera for a long period of time.

Monitor/viewfinder

- Do not exert excessive force on the monitor. This may cause uneven display and damage it.
- In cold climates or other situations when the camera becomes cold, the monitor or the viewfinder may appear slightly darker than normal immediately after the camera is turned on. Normal brightness will return once the internal components have warmed up.

The monitor and viewfinder are made with extremely high precision technology. However there may be some dark or bright spots (red, blue or green) on the screen. This is not a malfunction. The monitor and viewfinder screens are controlled with extremely high precision, but some pixels may be inactive. The spots will not be recorded on pictures on a card.

Lens

- Do not exert excessive force on the lens.
- Images may appear slightly white if the front lens surface is dirty (fingerprints, etc.). Turn the camera on, hold the extracted lens barrel with your fingers, and gently wipe the lens surface with a soft, dry cloth.
- Do not leave the camera with the lens facing the sun as rays of light from the sun may cause it to malfunction. Also, be careful when placing the camera outside or near a window.
- Do not touch the lens shutter, as this may damage the lens. Be careful when removing the camera from a bag, etc.

Battery

The battery is a rechargeable lithium ion battery.

It is easily affected by temperature and humidity, and is affected more when the temperature is high or low.

- Remove the battery from the camera after use.
 - Keep the battery in a plastic bag, making sure that it is kept away from metallic objects (such as clips) when carrying or storing it.
- The time required for charging varies depending on conditions of battery usage. Charging takes longer at high or low temperatures and when the battery has not been used in some time.
- The battery will be warm during charging and for some time thereafter.
- The battery will run out if not used for long periods of time, even after being charged.
- Do not leave any metal items (such as clips) near the contact areas of the power plug. Otherwise, a fire and/or electric shocks may be caused by short-circuiting or the resulting heat generated.
- Frequently charging up the battery is not recommended.
(Doing so reduces the maximum usage time and can cause the battery to expand.)
- If the available battery power is significantly reduced, the battery is reaching the end of its lifespan. Please purchase a new battery.
- When charging:
 - Wipe dirt from the battery terminals with a dry cloth.
 - Keep at least 1 m (3' 3") away from AM radios (may cause radio interference).
- Do not use a damaged or dented battery (especially terminals), e.g. by dropping (can cause faults).

AC adapter

- Keep at least 1 m (3' 3") away from AM radios (may cause radio interference).
- The AC adapter may generate whirring sounds when it is being used. This is not a malfunction.
- After use, be sure to disconnect the power supply device from the electrical outlet. (A very small amount of current is consumed if it is left connected.)

Memory cards

- To prevent damage to cards and data
 - Avoid high temperatures, direct sunlight, electromagnetic fields, and static electricity.
 - Do not bend, drop, or expose to strong impacts.
 - Put the card in its case or the storage bag after use and when storing or carrying it.
 - Do not touch the card's terminals or allow them to become dirty or wet.
- Recorded data may be damaged or lost if the camera breaks down due to inappropriate handling. Leica Camera AG will not be liable for any damage caused due to loss of recorded data.
- When disposing of/transferring memory cards
 - If using the "format" or "delete" functions on your camera or computer, this only changes the file management information, and does not completely delete the data from within the memory card. When disposing of or transferring your memory cards, we recommend physically destroying them, or using commercially available computer data erasing software to completely delete the data from the card. Data within memory cards should be managed responsibly.

When using a tripod or unipod

- Do not apply excessive force or tighten screws when they are damaged. (This may damage the camera, screw hole, or label.)
- Ensure that the tripod is stable. (Refer to the tripod instructions.)
- You may not be able to remove the card or the battery when using a tripod or unipod.

Personal Information

To protect personal information, we recommend that you set a Wi-Fi password or a Wi-Fi function lock. (→255)

If names or birthdays are set in [Profile Setup] or in the [Face Recog.] function, keep in mind that the camera and recorded pictures will contain personal information.

Be sure to pay special attention to the privacy, likeness rights, etc. of a subject and take your own responsibility when you use the [Silent Mode], or use functions such as writing the location information and changing the shutter noise, etc.

● Disclaimer

- Data containing personal information can be altered or lost due to malfunction, static electricity, accidents, breakdowns, repairs, or other operations.

Leica Camera AG will not be liable for any damage that occurs, direct or indirect, as a result of the alteration or loss of data containing personal information.

● When ordering repairs or transferring/disposing of the camera

- After you make a note of the personal information, perform [Reset Network Settings]/ [Delete account] to delete data containing personal information such as wireless LAN connection settings that you registered or set in this camera. (→205)
- To protect your personal information, please reset the settings. (→205)
- Remove the memory card from the camera.
- When ordering repairs, settings may be returned to the initial purchase state.
- If the above operations cannot be performed because of a camera malfunction, consult your dealer or the nearest Leica Customer Care department.

● When transferring or disposing of your memory card, see “When disposing of/ transferring memory cards” in the previous section. (→288)

● Uploading pictures to WEB services

- Pictures may contain personal information that can be used to identify the user, such as titles, recording dates and times, and location information. Before uploading the pictures to WEB services, check the pictures carefully for information that should not be disclosed.

Wi-Fi function

■ Use the camera as a wireless LAN device

When using equipment or computer systems that require more reliable security than wireless LAN devices, ensure that the appropriate measures are taken for safety designs and defects for the systems used. Leica Camera AG will not take any responsibility for any damage that arises when using the camera for any purpose other than as a wireless LAN device.

■ Use of the Wi-Fi function of this camera is presumed to be in countries where this camera is sold

There is the risk that the camera violates the radio transmission regulations if used in countries other than those where this camera is sold, and Leica Camera AG takes no responsibility for any violations.

■ There is the risk that data sent and received via radio transmission may be intercepted

Please note that there is the risk that data sent and received via radio transmission may be intercepted by a third party. We strongly recommend that you enable encryption in the settings of your wireless access point to ensure information security.

■ Do not use the camera in areas with magnetic fields, static electricity or interference such as near microwave ovens. Radio transmission may not reach the camera.

- Using the camera near devices such as microwave ovens or cordless telephones that use the 2.4 GHz radio wave band may cause a decrease in performance in both devices.

■ Do not connect to the wireless network you are not authorized to use

When the camera utilizes its Wi-Fi function, wireless networks will be searched automatically. When this happens, wireless networks that you are not authorized to use (SSID*) may be displayed, however do not attempt to connect to the network as it may be considered as unauthorized access.

* SSID refers to the name that is used to identify a network over a wireless LAN connection. If the SSID matches for both devices, transmission is possible.

- The SDXC Logo is a trademark of SD-3C, LLC.
- The terms HDMI and HDMI High-Definition Multimedia Interface, and the HDMI Logo are trademarks or registered trademarks of HDMI Licensing Administrator, Inc. in the United States and other countries.
- Dolby, Dolby Audio, and the double-D symbol are trademarks of Dolby Laboratories.
- Leica is a registered trademark of Leica Microsystems IR GmbH.
- Vario-Elmar is a registered trademark of Leica Camera AG.
- Adobe is a trademark or registered trademark of Adobe Systems Incorporated in the United States and/or other countries.
- Windows is either registered trademark or trademark of Microsoft Corporation in the United States and/or other countries.
- iMovie, Mac, OS X and macOS are trademarks of Apple Inc., registered in the U.S. and other countries.
- iPad, iPhone, iPod, and iPod touch are trademarks of Apple Inc., registered in the U.S. and other countries.
- App Store is a service mark of Apple Inc.
- Android and Google Play are trademarks or registered trademarks of Google Inc.
- The Bluetooth® word mark and logos are registered trademarks owned by the Bluetooth SIG, Inc. and any use of such marks by Leica Camera AG is under license. Other trademarks and trade names are those of their respective owners.
- The Wi-Fi CERTIFIED™ Logo is a certification mark of Wi-Fi Alliance®.
- The Wi-Fi Protected Setup™ Logo is a certification mark of Wi-Fi Alliance®.
- “Wi-Fi®” is a registered trademark of Wi-Fi Alliance®.
- “Wi-Fi Protected Setup™”, “WPA™”, and “WPA2™” are trademarks of Wi-Fi Alliance®.
- QR Code is a registered trademark of DENSO WAVE INCORPORATED.
- This product uses “DynaFont” from DynaComware Corporation. DynaFont is a registered trademark of DynaComware Taiwan Inc.
- Other names, company names, and product names mentioned in these instructions are trademarks or registered trademarks of the companies concerned.



This product is licensed under the AVC Patent Portfolio License for the personal use of a consumer or other uses in which it does not receive remuneration to (i) encode video in compliance with the AVC Standard ("AVC Video") and/or (ii) decode AVC Video that was encoded by a consumer engaged in a personal activity and/or was obtained from a video provider licensed to provide AVC Video. No license is granted or shall be implied for any other use. Additional information may be obtained from MPEG LA, L.L.C.
See <http://www.mpegla.com>

This product incorporates the following software:

- (1) the software developed independently for Leica Camera AG,
- (2) the software owned by third party and licensed to Leica Camera AG,
- (3) the software licensed under the GNU General Public License, Version 2.0 (GPL V2.0),
- (4) the software licensed under the GNU LESSER General Public License, Version 2.1 (LGPL V2.1), and/or
- (5) open source software other than the software licensed under the GPL V2.0 and/or LGPL V2.1.

The software categorized as (3) - (5) are distributed in the hope that it will be useful, but WITHOUT ANY WARRANTY, without even the implied warranty of MERCHANTABILITY or FITNESS FOR A PARTICULAR PURPOSE. Please refer to the detailed terms and conditions thereof displayed by selecting [MENU/SET] → [Setup] → [Version Disp.] → [Software info].

Leica Service Addresses

Leica Product Support

The Leica Product Support department can provide you with an answer to any technical questions relating to Leica products, including software supplied, either in writing, on the telephone or by e-mail.

It is also the contact point for purchasing advice and to order instructions.

Alternatively, you can send us your questions using the contact form on the Leica Camera AG homepage.

Leica Camera AG

Product Support / Software Support

Am Leitz-Park 5

D-35578 Wetzlar

Telephone: +49 (0) 6441-2080-111 /-108

Fax: +49 (0) 6441-2080-490

info@leica-camera.com / software-support@leica-camera.com

Leica Customer Care

For servicing your Leica equipment or in the event of damage, the Leica Camera AG Customer Care department or the repair service provided by authorized Leica agents in your country are available (for addresses, see the Leica Camera AG homepage).

Leica Camera AG

Customer Care

Am Leitz-Park 5

D-35578 Wetzlar

Telephone: +49 (0) 6441-2080-189

Fax: +49 (0) 6441-2080-339

customer.care@leica-camera.com



DAS WESENTLICHE.

Leica Camera AG | Am Leitz-Park 5 | 35578 WETZLAR | DEUTSCHLAND

Telefon +49(0)6441-2080-0 | Telefax +49(0)6441-2080-333 | www.leica-camera.com

LEICA FOTOS

The camera can be controlled remotely using a smartphone/tablet PC. This will require an installation of the Leica FOTOS app on the mobile device.

- ▶ Scan the following QR code with the mobile device



or

- ▶ The app is available from Apple App Store™/Google Play Store™

CONNECTION

FIRST-TIME CONNECTION TO A MOBILE DEVICE

The connection is established via Bluetooth. A pairing of the camera and the mobile device is required for a first-time connection to a mobile device.

CONNECTION WIZARD

The connection wizard appears at initial startup of the camera or after a camera reset. These settings are also available via the menu item **Leica FOTOS**.

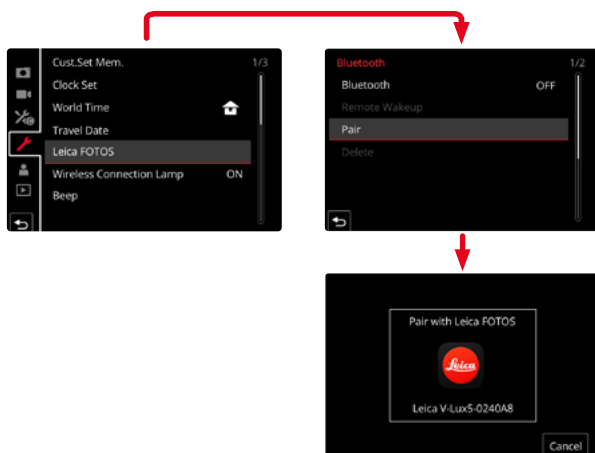

USING THE MENU TO

ON THE MOBILE DEVICE

- ▶ Activate Bluetooth
- ▶ Launch the Leica FOTOS app
- ▶ Select the camera model

IN THE CAMERA

- ▶ Select **Leica FOTOS** in the main menu
- ▶ Select **Bluetooth**
 - Bluetooth is activated.
- ▶ Follow the Leica FOTOS instructions
 - The relevant icons appear on the LCD panel and the status LED lights in blue once a connection is established successfully.

Notes

- The pairing process may take a few minutes to complete.
- Each mobile device only needs to be paired with the camera once. The process adds the device to the list of known devices.
- GPS data will be automatically determined and written to the Exif data when pictures are taken while the camera is connected to the Leica FOTOS app.

CONNECTING TO KNOWN DEVICES

- ▶ Select **Leica FOTOS** in the main menu
- ▶ Select **Bluetooth**
- ▶ Select **On**
 - Activate the Bluetooth function.
 - The camera connects to the mobile device automatically.

Notes

- Should there be more than one known device in the vicinity of the camera, then it will automatically connect to the first device responding. A favorite mobile device cannot be specified.
- We recommend removing rarely used devices from the list of known devices to prevent unwanted connections.
- Disconnect and reconnect (i.e. deactivating and reactivating Bluetooth in the camera) if the wrong device was connected.

REMOVING DEVICES FROM THE LIST OF KNOWN DEVICES

- ▶ Select **Leica FOTOS** in the main menu
- ▶ Select **Delete**
- ▶ Select the relevant device
 - A security prompt appears on the LCD panel.
- ▶ Select **Yes**

Note

- The pairing process will have to be repeated to reconnect a deleted device to the camera.

REMOTE CAMERA CONTROL

You can take pictures and record video remotely via the mobile device, and can also change image settings or transfer data to the mobile device. A list of available functions and instructions for their use can be found in the Leica FOTOS app.

REMOTE CAMERA ACTIVATION

The camera can be activated remotely from off or standby if this function is activated in the camera. The Bluetooth function must be active.

- ▶ Select **Leica FOTOS** in the main menu
- ▶ Select **Remote Wakeup**
- ▶ Select **On**
 - The camera will scan for known devices and automatically establishes a connection.

Important information

- Remote activation will activate the camera even if it was switched off via the main switch.
- Accidental remote camera activation may result in unwanted pictures taken and excessive power consumption.
- A third-party device can – provided it has been paired with the camera – access the camera remotely if your own mobile device is not currently connected or its Bluetooth function is deactivated. This poses a danger of unauthorized access to your data or camera functions.

Solution

- Only activate this function just before you want to use it.
- Disable the function as soon as it is no longer needed.